

Instruction Manual

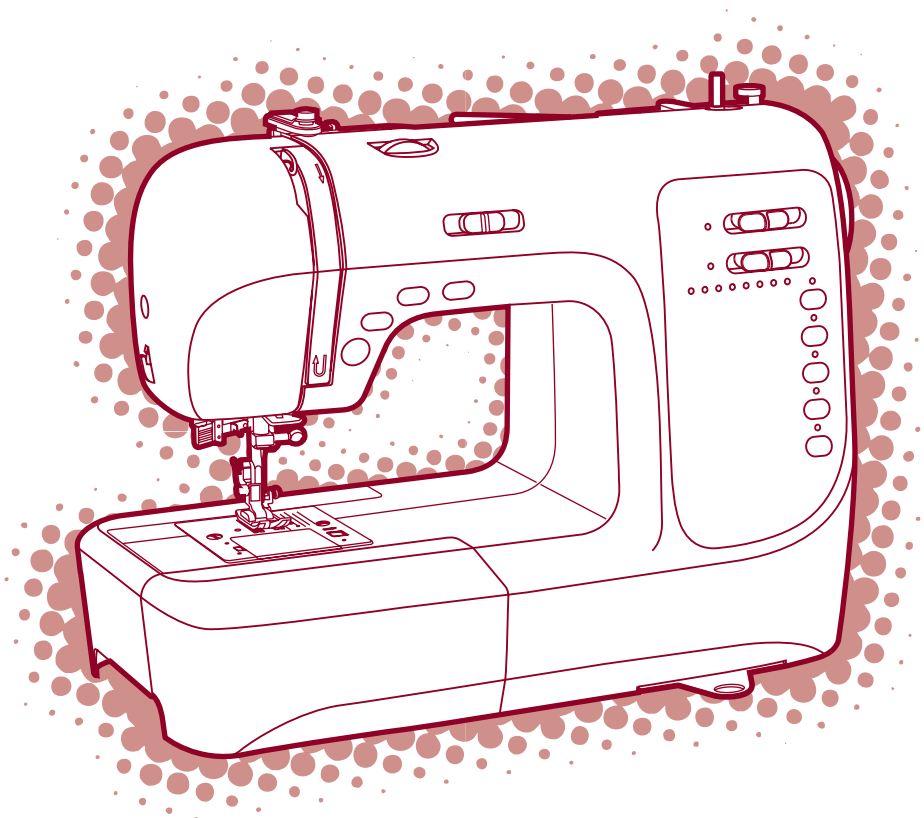

Important safety instructions

When using an electrical appliance, basic safety should always be followed, including the following:
Read all instructions before using this sewing machine.

DANGER -To reduce the risk of electric shock:

1. An appliance should never be left unattended when plugged in.
2. Always unplug this appliance from the electric outlet immediately after using and before cleaning.

WARNING -To reduce the risk of burns, fire, electric shock, or injury to persons:

1. Do not allow to be used as a toy. Close attention is necessary when this appliance is used by or near children.
2. Use this appliance only for its intended use as described in this manual. Use only the attachments recommended by the manufacturer as contained in this manual.
3. Never operate this appliance if it has a damaged cord or plug, if it is not working properly, if it has been dropped or damaged, or dropped into water. Return the appliance to the nearest authorized dealer or service center for examination, repair, electrical or mechanical adjustment.
4. Never operate the appliance with any air openings block. Keep ventilation openings of the sewing machine and foot controller free from accumulation of lint, dust, and loose cloth.
5. Keep fingers away from all moving parts. Special care is required around the sewing machine needle.
6. Always use the proper needle plate, a wrong needle plate can cause the needle to break.
7. Do not use bent needles.
8. Do not pull or push fabric while stitching. It may deflect the needle causing it to break.
9. Switch the sewing machine off ("O") when making any adjustments in the needle area, such as threading needle, changing needle, threading bobbin, or changing presser foot, and the light.
10. Always unplug sewing machine from the electrical outlet when removing covers, lubricating, or when making any other user servicing adjustments mentioned in the instruction manual.
11. Never drop or insert any object into any opening.
12. Do not use outdoors.
13. Do not operate where aerosol spray products are being used or where oxygen is being administered.
14. To disconnect, turn all controls to the off ("O") position, then remove plug from outlet.
15. Do not unplug by pulling on cord. To unplug, grasp the plug, not the cord.
16. The sound pressure level under normal operating conditions is 75dB(A).
17. Please turn off the machine or unplug when the machine is not operating properly.
18. Never place anything on the foot controller.
19. This appliance is not intended for use by persons (including children) with reduced physical, sensory or mental capabilities, or lack of experience and knowledge, unless they have been given supervision or instruction concerning use of the appliance by a person responsible for their safety.
20. Children should be supervised to ensure that they do not play with the appliance.

SAVE THESE INSTRUCTIONS

This sewing machine is intended for household use only.

Principal parts of the machine	1
Accessories	2
Connecting the machine to the power source	3
Starting sewing	4
Start/stop button	4
Foot control	4
Changing the presser foot	5
Type of presser foot chart	6
Replacing the needle	7
Matching needle/ fabric/ thread	7
Winding the bobbin	8-9
Inserting the bobbin	10
Threading the upper thread	11-12
Using the needle threader	13
Thread tension	14
Raising up the lower thread	15
Cutting the thread	15
Two-step presser foot lifter	16
To raise or drop the feed dogs	16
Function of machine	17-19
Start/stop button (1)	17
Reverse button (2).....	17
Auto-lock button (3)	17
Needle up/ down position button (4).....	18
Speed limiting adjustment lever (5)	18
Stitch width adjustment lever (6)	18
Stitch length adjustment lever (7)	19
Pattern selection buttons (8)	19
Pattern chart	20
Useful skills	21-22
Sewing corners	21
Reverse	21
Free arm	21
Installing the extension table	22
Sewing on the heavy fabric	22
Straight stitches and needle position	23
Zigzag stitches	23
Stretch stitch	24

Overcasting stitches	25
Using the overcasting foot	25
Using the all purpose foot	25
Blind hem/ Lingerie stitch	26
Button sewing	27
Buttonhole stitching	28-30
Making a buttonhole on stretch fabrics	30
Darning stitch	31-32
Zipper insertion	33-34
Inserting a centered zipper	33
Inserting a side zipper	34
Narrow hemming	35
Cording	36
Single cording	36
Triple cording	36
Satin stitch sewing	37
Quilting	38
Scallop stitch	38
Gathering	39
Gathered fabric	39
To gather and attach gathered fabric in one step	39
Smocking	40
Free motion darning, embroidery and monogramming	41-42
Darning	41
Embroidery	42
Monogramming	42
Fagoting	43
Patchwork stitching	43
Twin needle	44
Walking foot	45
Warning functions	46
Warning beeping sound	46
Return bobbin winder spindle to left	46
Maintenance	46-47
Cleaning the sewing machine surface	46
Cleaning the hook	46
Trouble shooting guide	48-49

Principal parts of the machine

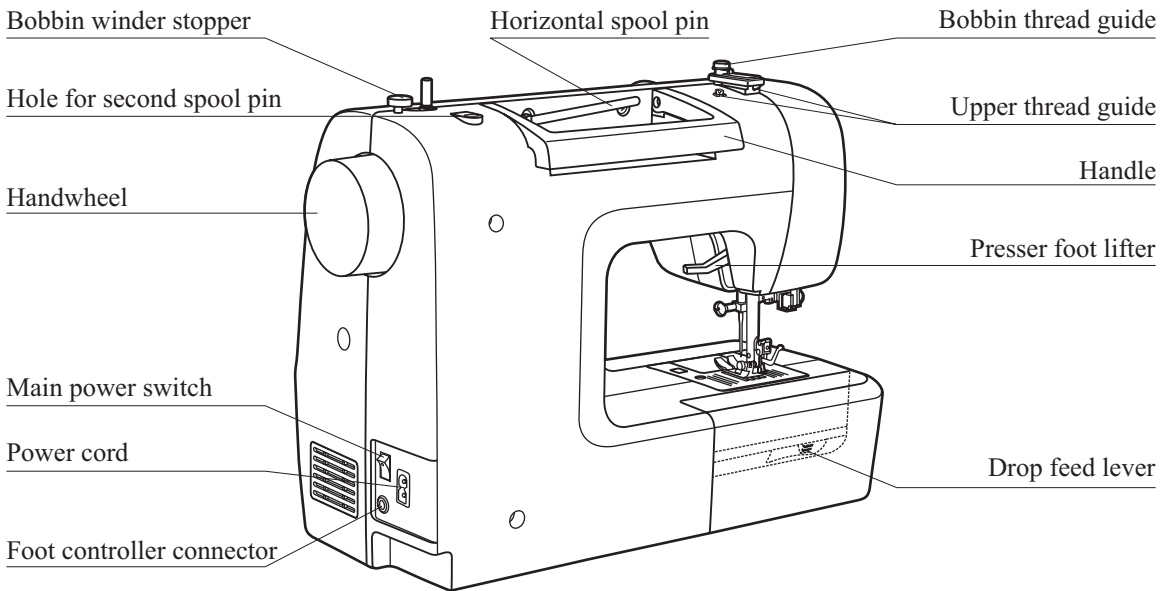
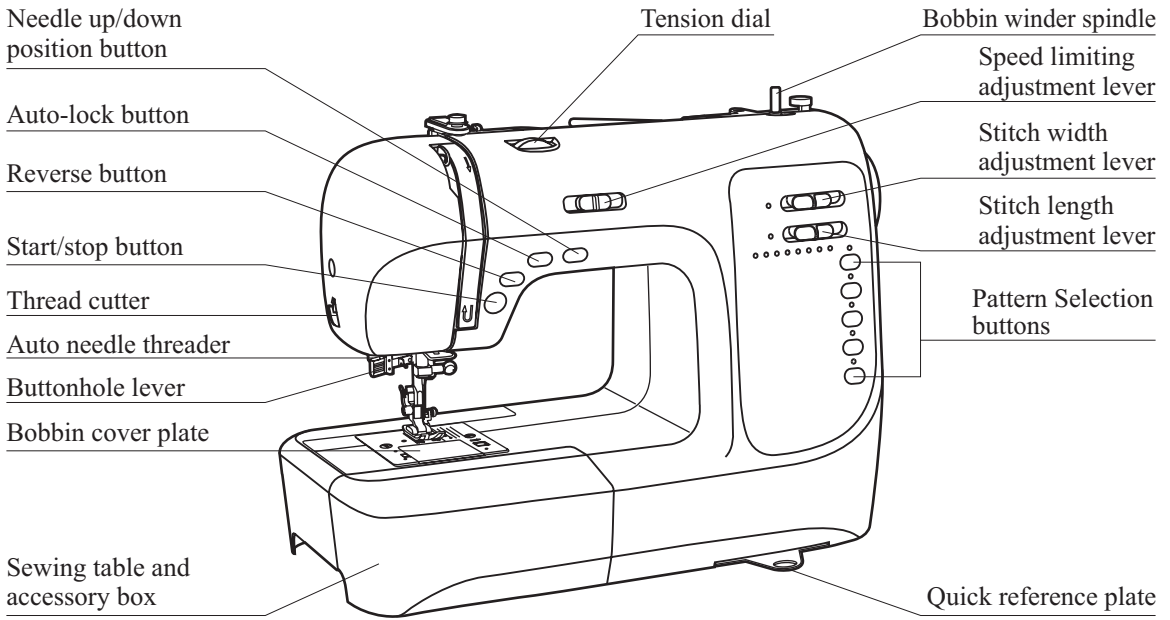

Accessories

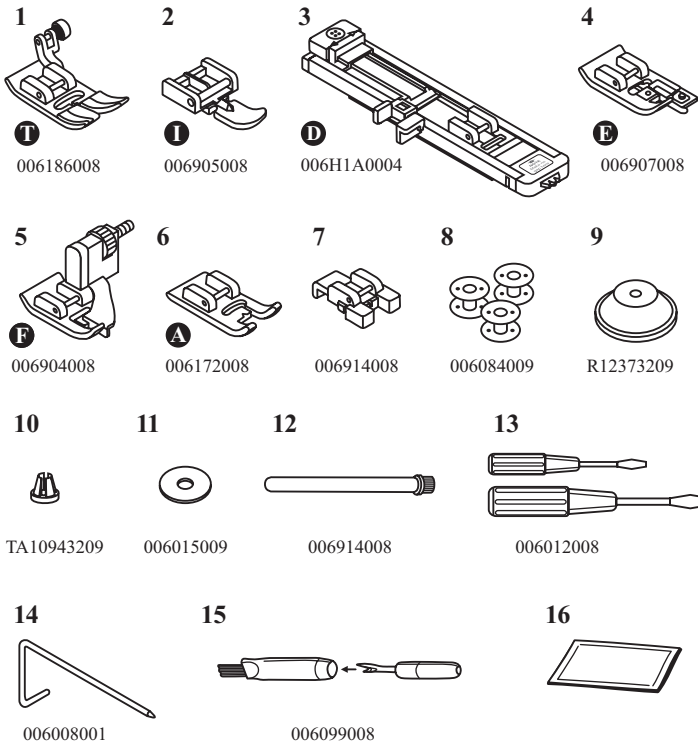

Standard

1. All purpose foot (T)
2. Zipper foot (I)
3. Buttonhole foot (D)
4. Overcasting foot (E)
5. Blind hem foot (F)
6. Satin stitch foot (A)
7. Button sewing foot
8. Bobbin (3x)
9. Spool holder (Large)
10. Spool holder (Small)
11. Spool pin felt
12. Second spool pin
13. Screwdriver (L & S)
14. Edge/quilting guide
15. Brush/ Seam ripper
16. Needle (3x)

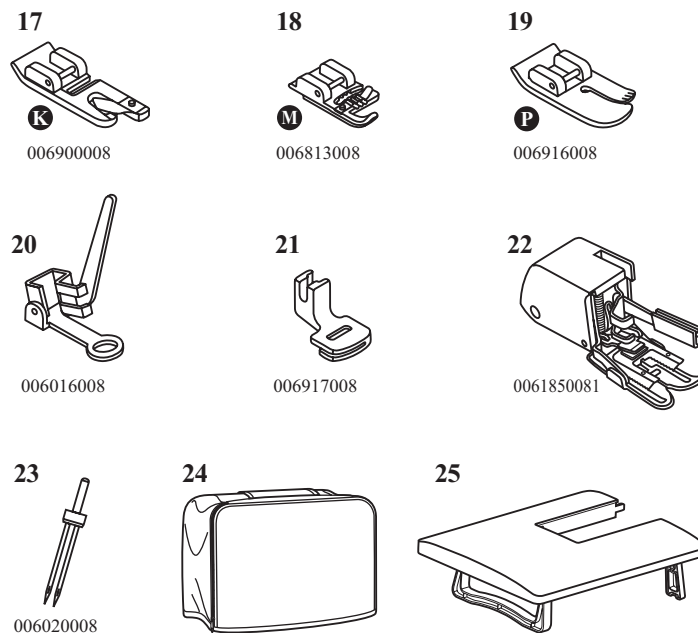

Optional

17. Hemmer foot (K)
18. Cording foot (M)
19. Quilting foot (P)
20. Darning/ Embroidery foot
21. Gathering foot
22. Walking foot
23. Twin needle
24. Rigid cover
25. Extension table

Connecting the machine to the power source

! Caution: Always make sure that the machine is unplugged from power source and the main switch is on ("O"), when the machine is not in use and before inserting or removing parts.

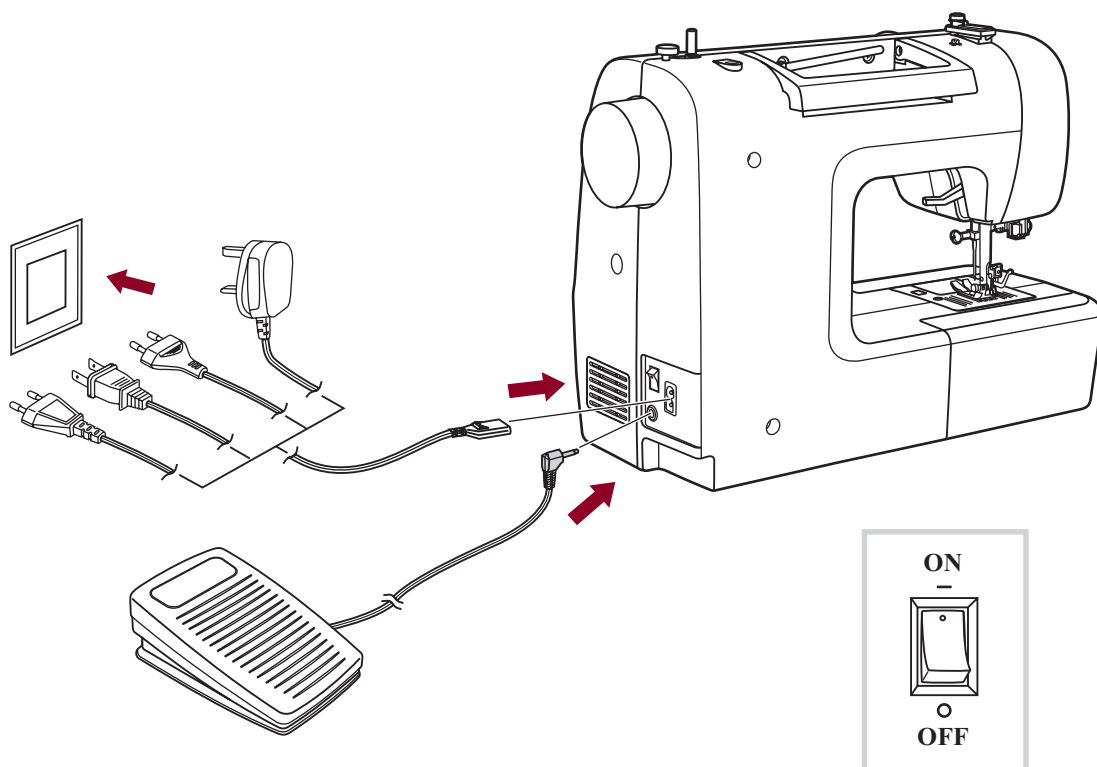

Connecting the machine

Before connecting the power supply, make sure that the voltage and frequency shown on the machine is conforming with your electrical power.

Place the machine on a stable table.

1. Connect the power line cord to the machine by inserting the 2-hole plug into the terminal box.
2. Connect the power line plug to the electric outlet.
3. Turn on the power switch.
4. The sewing lamp will light up when the switch is turned on.

To disconnect, turn the power switch to the off position, then remove plug from outlet.

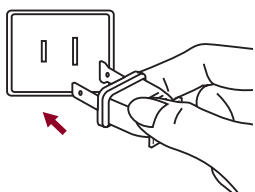

Polarized plug information

This appliance has a polarized plug (one blade wider than the other), to reduce the risk of electrical shock; this plug will fit in a polarized outlet only one way. If the plug does not fit fully in the outlet, reverse the plug. If it still does not fit, contact a qualified electrician. Do not modify the plug in any way.

Starting sewing

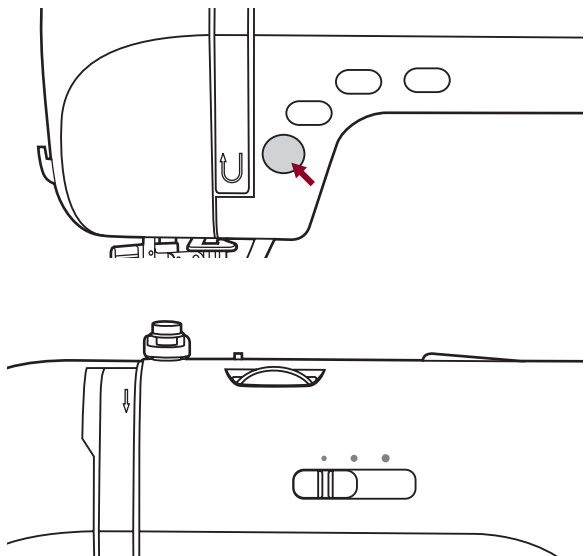

Start/stop button

The machine will start running when Start/stop button is pressed and will stop when pressed the second time.

The machine will rotate slowly at the beginning of the sewing.

The speed limiting adjustment lever can control the sewing speed. To increase the speed, slide the lever to the right, To decrease the sewing speed, slide the lever to the left.

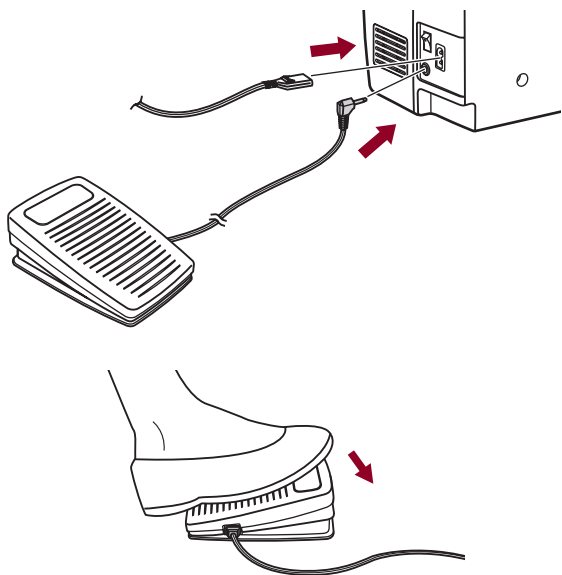

Foot control

With the sewing machine turned off, insert the foot control plug into its connector on the sewing machine.

Turn on the sewing machine, and then slowly depress the foot control to start sewing.

Release the foot control to stop the sewing machine.

⚠ Attention: Consult a qualified electrician if in doubt as how to connect the machine to the power source. Unplug the power cord when the machine is not in use.
The appliance must be used with the foot controller C-9000 manufactured by CHIEN HUNG TAIWAN., LTD.

Changing the presser foot

! *Attention: Turn power switch to off ("O") when carrying out any of the below operations!*

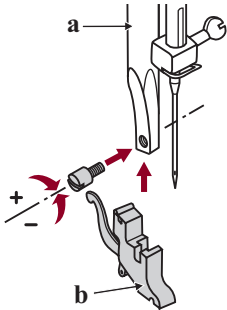

Attaching the presser foot holder

Raise the presser foot bar (a).

Attach the presser foot holder (b) as illustrated.

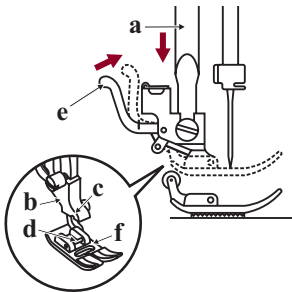

Attaching the presser foot

Lower the presser foot holder (b) until the cut-out (c) is directly above the pin (d).

Press the black lever (e).

Lower the presser foot holder (b) and the presser foot (f) will engage automatically.

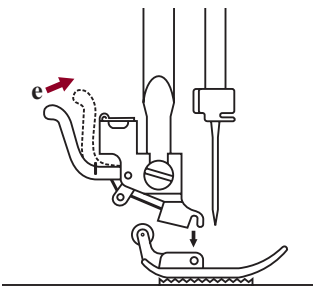

Removing the presser foot

Raise the presser foot.



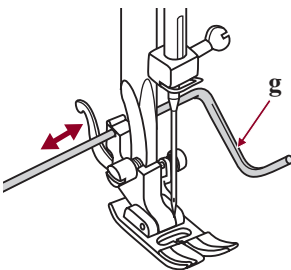



















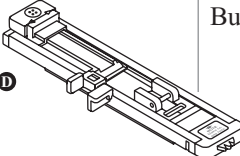

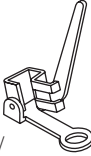











Press the black lever (e) and the foot will disengage.

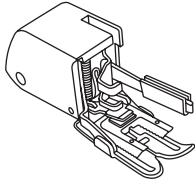

Attaching the edge/quilting guide

Attach the edge/quilting guide (g) in the slot as illustrated. Adjust according to need for hems, pleats, etc.

Type of presser foot chart

PRESSER FOOT	APPLICATION	NEEDLE	PRESSER FOOT	APPLICATION	NEEDLE
 All purpose foot (T)	General sewing, Patchwork stitches, Decorative stitching, Smocking, Fagoting, etc.	 	 Cording foot (M) (Optional)	Cording 	
 Zipper foot (I)	Inserting zippers 		 Hemmer foot (K) (Optional)	Narrow hemming 	
 Buttonhole foot (D)	Buttonhole sewing 		 Darning/ Embroidery foot (Optional)	Darning Free embroidery Monogramming 	
 Button sewing foot	Button sewing 		 Quilting foot (P) (Optional)	Quilting 	
 Blind hem foot (F)	Blind hem stitching 		 Gathering foot (Optional)	Gathering 	
 Overcasting foot (E)	Overcasting 		 Walking foot (Optional)	This foot helps to prevent uneven feeding of very difficult fabrics	
 Satin stitch foot (A)	Satin stitch sewing 				

Note: The twin needle is optional. It is not include with the accessories.
 When sewing with twin needle, the stitch width should be set at less than "5.0".

Replacing the needle

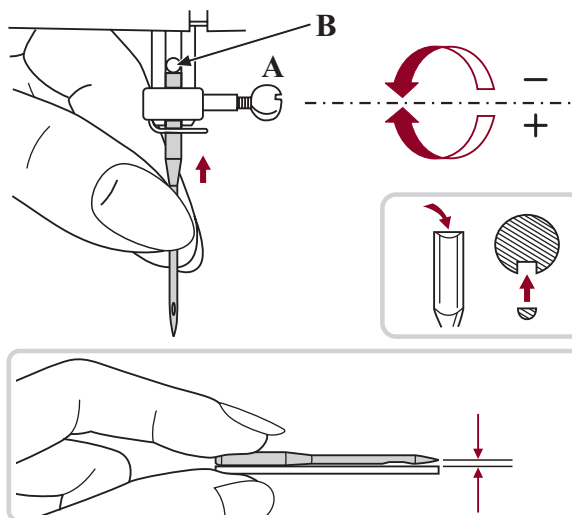

! Attention: Turn power switch to off ("O") when carrying out any of the above operations!

Change the needle regularly, especially if it is showing signs of wear and causing problems. Insert the needle following the illustrated instructions.

- A. Loosen the needle clamp screw and tighten again after inserting the new needle. The flat side of the shaft should be towards the back.
B. Insert the needle as far up as it will go.

Needles must be in perfect condition.

Problems can occur with:

- Bent needles
- Blunt needles
- Damaged points

Matching needle/ fabric/ thread

NEEDLE, FABRIC, THREAD SELECTION GUIDE

NEEDLE SIZE	FABRICS	THREAD
9-11 (70-80)	Lightweight fabrics-thin cottons, voile, serge, silk, muslin, Qiana, interlocks, cotton knits, tricot, jerseys, crepes, woven polyester, shirt & blouse fabrics.	Light-duty thread in cotton, nylon, polyester or cotton wrapped polyester.
11-14 (80-90)	Medium weight fabrics-cotton, satin, sailcloth, double knits, lightweight woollens.	Most threads sold are medium size and suitable for these fabrics and needle sizes. Use polyester threads on synthetic materials and cotton on natural woven fabrics for best results. Always use the same thread on top and bottom.
14 (90)	Medium weight fabrics-cotton duck, woolen, heavier knits, terycloth, denims.	
16 (100)	Heavyweight fabrics-canvas, woollens, outdoor tent and quilted fabrics, denims, upholstery material (light to medium).	
18 (110)	Heavy woollens, overcoat fabrics, upholstery fabrics, some leathers and vinyls.	Heavy duty thread, carpet thread.

➔ Please Note:

- In general, fine threads and needles are used for sewing fine fabrics, and thicker threads are used for sewing heavy fabrics.
- Always test thread and needle size on a small piece of fabric which will be used for actual sewing.
- Use the same thread for needle and bobbin.

Winding the bobbin

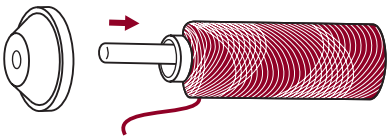
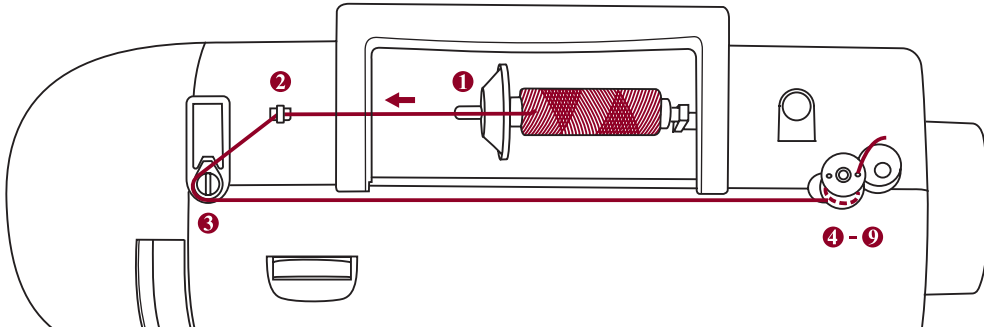

1. Place the thread and spool holder onto the spool pin.

For smaller spools of thread, place spool holder with the small side next to the spool or use the small spool holder.

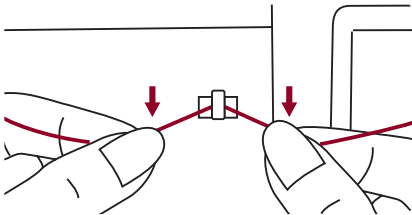

2. Snap the thread into the thread guide .

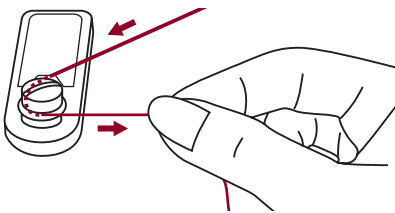

3. Wind the thread contrary clockwise around the bobbin winder tension discs.

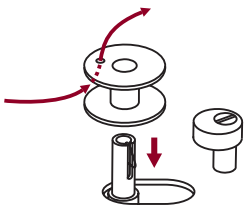

4. Place the thread end through one of the inner holes in the bobbin as illustrated and place empty bobbin on the spindle.



5. Push the bobbin to right.

Winding the bobbin

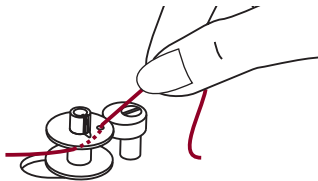

6. Hold the thread tail securely in one hand.

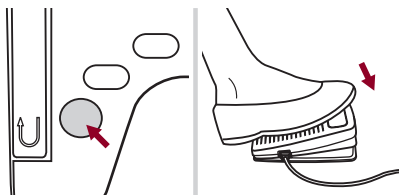

7. Press on the foot control or the Start/Stop button to start winding the bobbin.

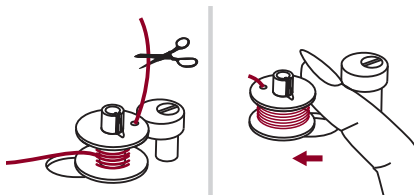

8. After the bobbin has wound a few turns stop the machine and cut the thread near the hole of the bobbin. Continue filling the bobbin until it is full. The motor stops automatically when the bobbin is full. Stop the machine. Push the bobbin winder spindle to left.

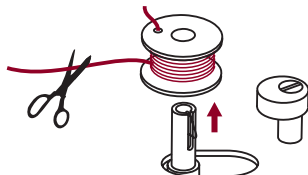

9. Cut the thread and then remove the bobbin.

 **Please Note:** When the bobbin winder switch is placed on the right, "bobbin winding position", the machine will not sew and the handwheel will not turn. To start sewing, push the bobbin winder switch to the left "sewing position".

Inserting the bobbin

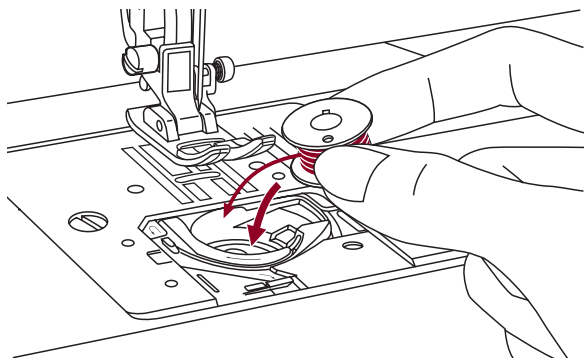

⚠ Attention: Turn power switch to off ("O") before inserting or removing the bobbin.

When inserting or removing the bobbin, the needle must be fully raised.

Insert the bobbin in the bobbin case with the thread running in a counterclockwise direction (arrow).

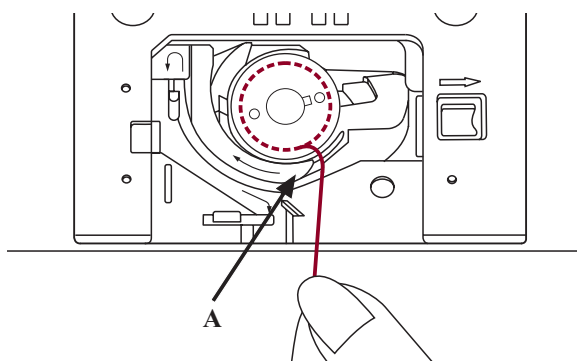

Pull the thread through the slit (A).

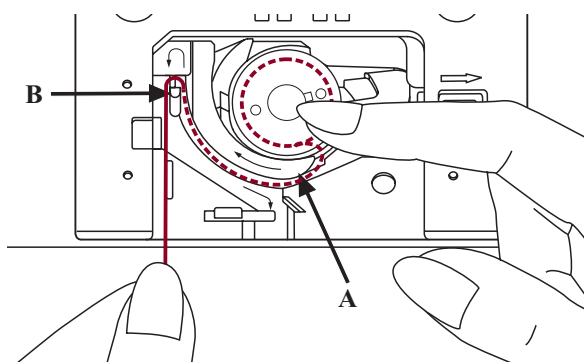

With a finger held gently on top of the bobbin. Draw the thread at the arrow markings into the stitch plate thread guide from (A) to (B).

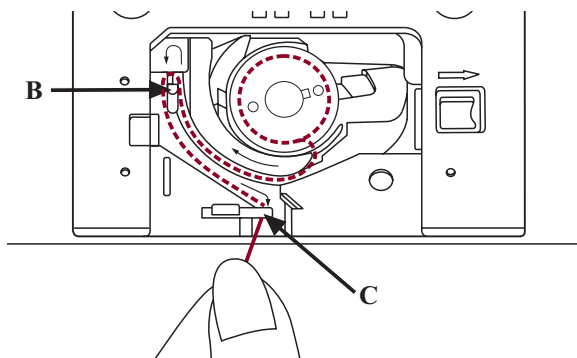

Pull the thread at the arrow markings into the stitch plate thread guide from (B) to (C).

To cut off excess thread pull thread back over the cutting off blade at point (C). Close the bobbin cover plate.

Threading the upper thread

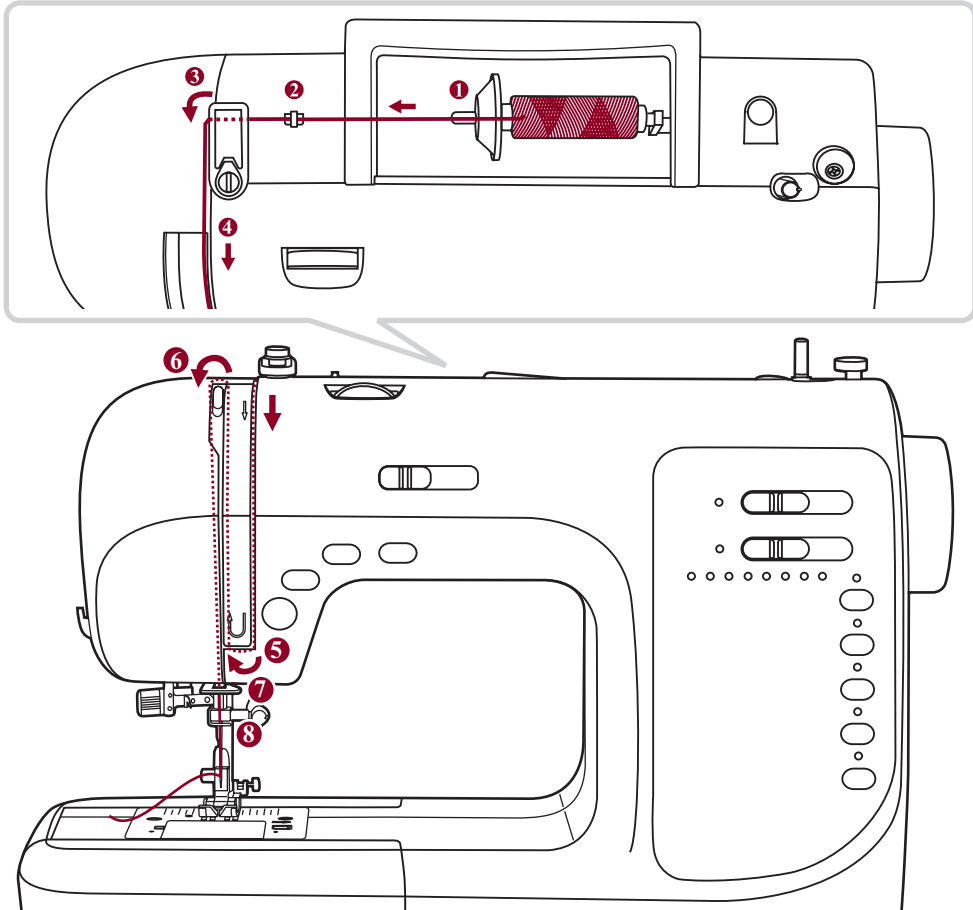

➡ **Please Note:** It is important to carry out the threading correctly as by not doing so several sewing problems could result.

Start by raising the needle to its highest point, and also raise the presser foot to release the tension discs.

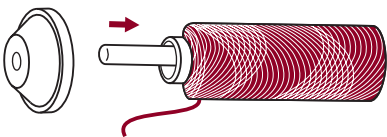

1. Lift up the spool pin. Place the spool of thread on the spool pin so that the thread comes from the front of the spool, then place the spool cap at the end of the spool pin.

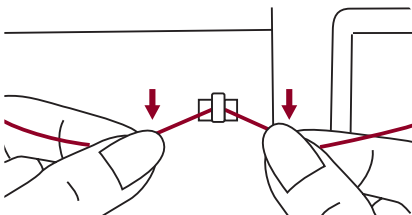

2. Draw the thread from the spool through the upper thread guide.

Threading the upper thread

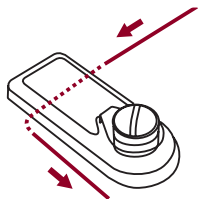

3. Guide the thread around the thread guide pulling the thread through the pre-tension spring as illustrated.

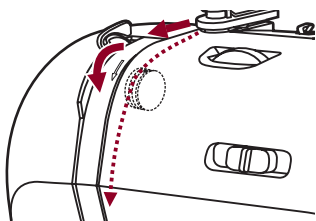

4. Thread the tension module by passing the thread between the silver discs.

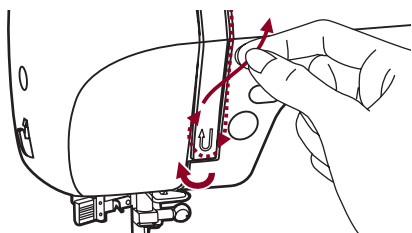

5. Then, down and around the check spring holder.

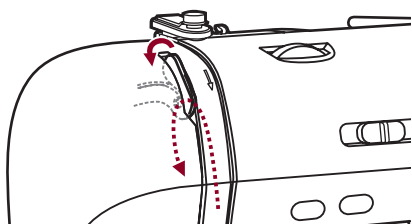

6. At the top of this movement, pass the thread from right to the left through the slotted eye of the take-up lever and then downwards again.

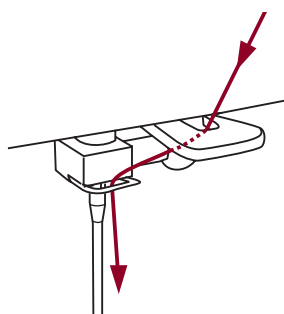

7. Pass the thread behind the flat, horizontal thread guide.
Guide the thread through the wire loop.
Pull the end of the thread through the needle from front to rear, and pull out about 10 cm of thread.
Use the needle threader to thread the needle. (On the next page.)

Using the needle threader

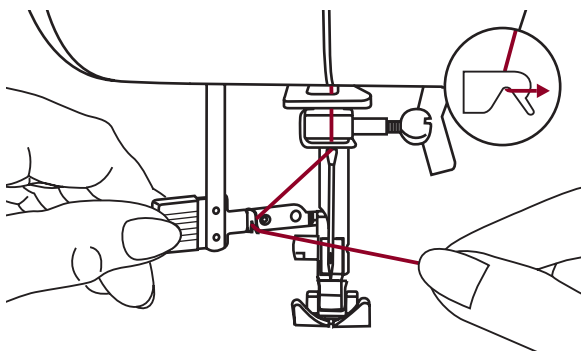

! *Attention:* Turn power switch to the off position ("O").

Raise the needle to its highest position and lower the presser foot.

Lower the needle threader lever slowly and draw the thread through the thread guide as illustrated and then to the right.

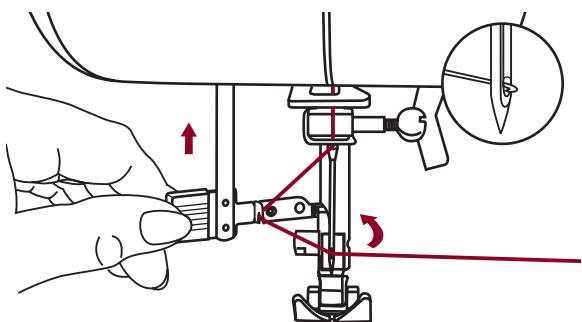

The needle threader automatically turns to the threading position and the hook pin passes through the needle eye.

Take the thread in front of the needle.

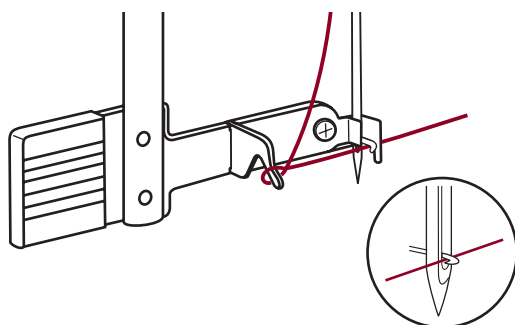

Hold the thread loosely and release the lever slowly. The hook will turn and pass the thread through the needle eye forming a loop.

Pull the thread through the needle eye.

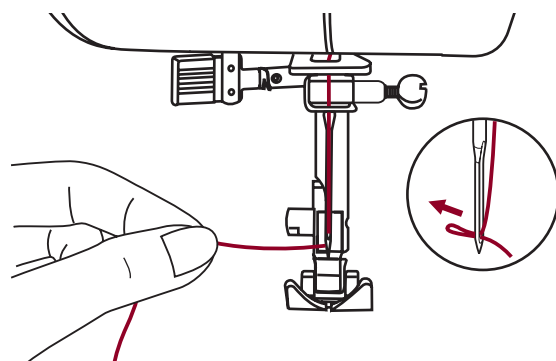

Thread tension

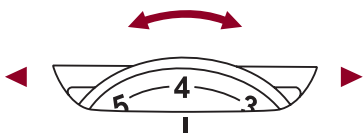

- Basic thread tension setting: "4"
- To increase the tension, turn the dial to the next number up. To reduce the tension, turn the dial to the next number down.
- Proper setting of tension is important to good sewing.
- For all decorative sewing you will always obtain a nicer stitch and less fabric puckering when the upper thread appears on the bottom side of your fabric.

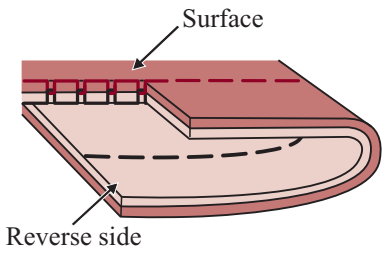

Normal thread tension for straight stitch sewing.

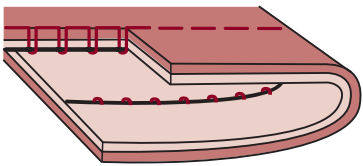
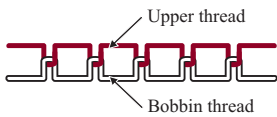

Thread tension is too loose for straight stitch sewing. Turn dial to higher number.

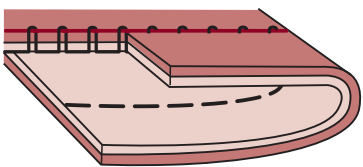

Thread tension is too tight for straight stitch sewing. Turn dial to lower number.

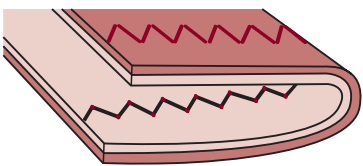

Normal thread tension for zig zag and decorative sewing.



Raising up the lower thread

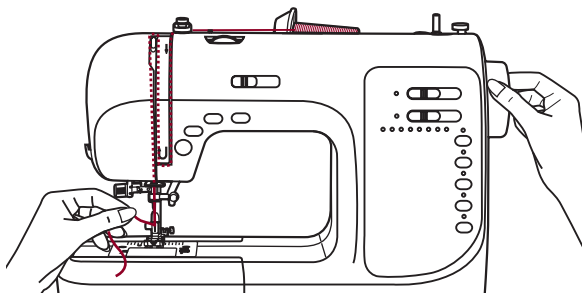

1. Hold the upper thread with the left hand. Turn the handwheel towards you (counterclockwise) lowering, then raising the needle.

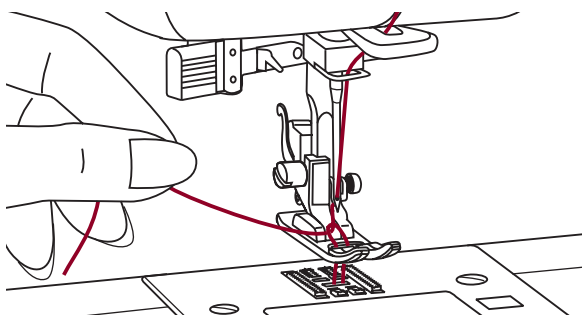

2. Gently pull on the upper thread to bring the bobbin thread up through the needle plate hole. The bobbin thread will come up in a loop.

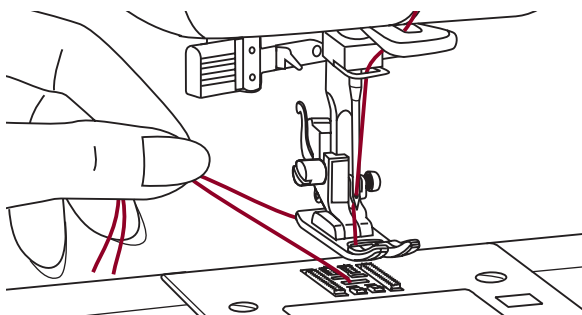

3. Pull both threads to the back under the presser foot.

Cutting the thread

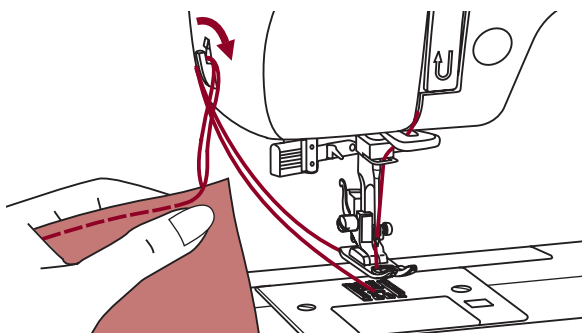

Raise the presser foot.
Remove the fabric, draw the threads to the left side of the face cover and cut using the thread cutter.

The threads are cut at the proper length to start the next seam.

Two-step presser foot lifter

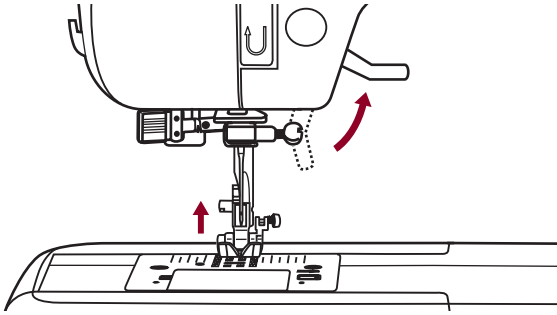

The presser foot lifter raises and lowers your presser foot.

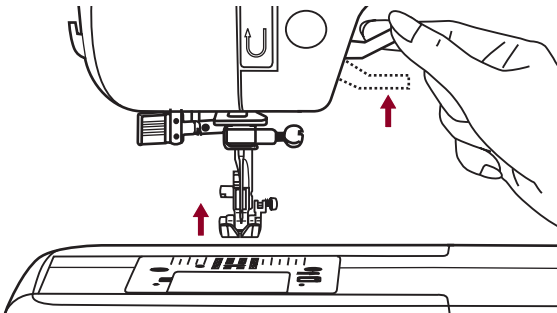

When sewing several layers or thick fabrics, the presser foot can be raised a second stage for easy positioning of the work.

To raise or drop the feed dogs

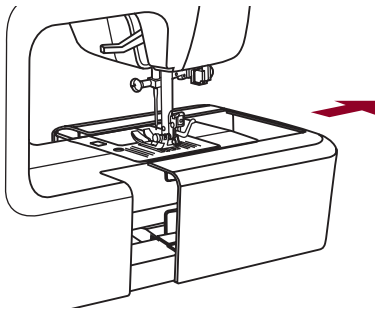

With the sewing table off the machine, the feed dog adjustment lever can be seen on the base in back of the sewing machine.

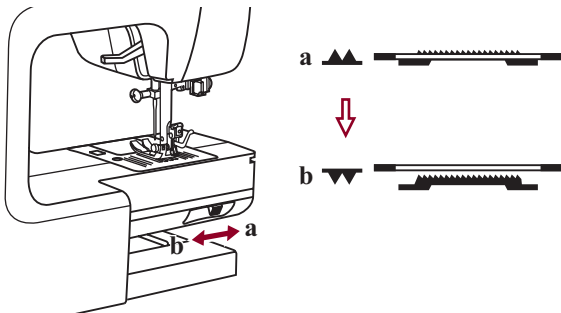

Sliding the lever to the "▼▼" (b) will lower the feed dog, for example during button sewing. If you wish to continue sewing normally, slide the lever to the "▲▲" (a) in order to raise the feed dogs.

The feed dog will not rise up if you do not turn the handwheel, even if the lever is slid to the right. Make a complete turn to raise the feed dogs.

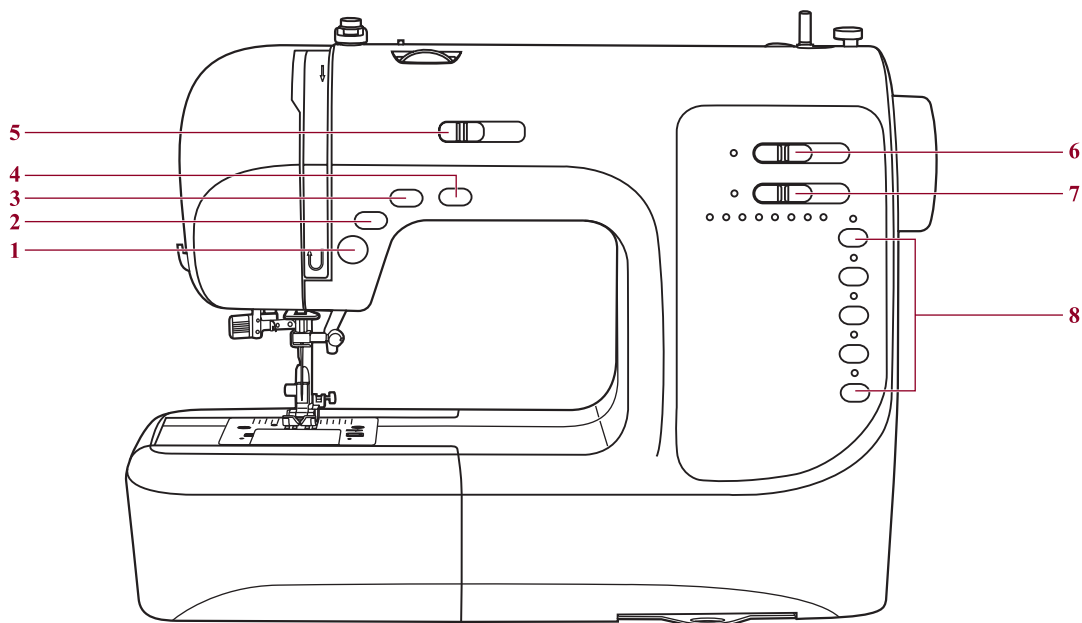

Start/stop button (1)



The machine will start running when start/stop button is pressed and will stop when pressed the second time. The machine will rotate slowly at the beginning of the sewing.

The sewing speed can be controlled by the speed limiting adjustment lever.

This way you may operate the machine without foot control.

Reverse button (2)



When the patterns 01-16, 21-40 are selected, the machine will sew reverse or a reinforcement stitch at a low speed if the reverse button is pressed. The machine will sew forward after the button is released.

Auto-lock button (3)



When the patterns 01-05 are selected, the machine will immediately sew 3 locking stitches when the Auto-lock button is pressed, then automatically stop.

When the patterns 06-16, 21-40 are selected, press the Auto-lock button, the machine will sew 3 locking stitches at the end of the current pattern and automatically stop.

The function will be cancelled if you press the button once again or select another pattern.



Needle up/ down position button (4)

With the Needle up/ down position button, you decide whether the needle shall stop in the up position or in the material when you stop sewing.

→ Please Note: During sewing, press the button will be no function. Needle up/ down position button setting will only machine stop.

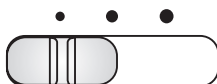

Speed limiting adjustment lever (5)

By adjusting the position of the speed limiting adjustment lever the top speed during sewing may be limited. The position of the slider defines the sewing speed at full stroke of the foot controller.

For slower speed: Slide toward left

For higher speed: Slide toward right

When the machine is run with the start/stop button the position of the speed limiting slider defines the actual sewing speed.

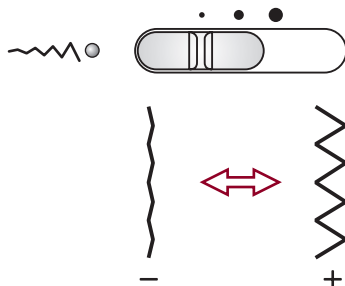

Stitch width adjustment lever (6)

When you select a stitch, the machine will automatically set the recommended stitch width. The stitch width can be regulated by sliding the stitch width adjustment lever.

Auto settings are easily determined by sliding the lever. The LED indicator next to the lever will blink and beep 1 time to indicate the setting is at the auto position.

When the setting is at the auto position, you can manually change the width according to your preference. Starting at the auto position, slide the lever to the left or right to locate each potential adjustment. At each manual adjustment point, the LED will blink 3 times and beep once.

For a narrower stitch, slide the lever to left. For a wider stitch, slide the lever to right. The stitch width can be adjusted between "0.0-7.0". Certain stitches have limited stitch widths.

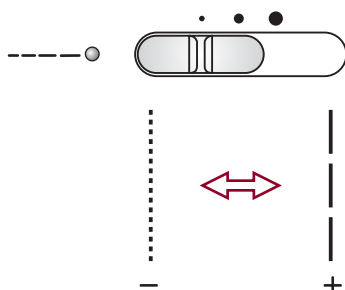

Stitch length adjustment lever (7)

When you select a stitch, the machine will automatically set the recommended stitch length. The stitch length can be regulated by sliding the stitch length adjustment lever.

Auto settings are easily determined by sliding the lever. The LED indicator next to the lever will blink and beep 1 time to indicate the setting is at the auto position.

When the setting is at the auto position, you can manually change the length according to your preference. Starting at the auto position, slide the lever to the left or right to locate each potential adjustment. At each manual adjustment point, the LED will blink 3 times and beep once.

To shorten the stitch length, slide the lever to left. For a longer stitch length, slide the lever to right. The stitch length can be adjusted between "0.0-4.5". Certain stitches have limited lengths.

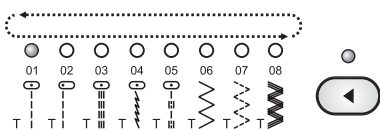









































Pattern selection buttons (8)

Turn on the power switch and the LED indicator above the straight stitch pattern will be lit.

To select other patterns, press the pattern selection button to the right of the row that contains your desired pattern. Stop when the LED indicator above your pattern is lit.

Pattern chart

Stitch Pattern		Width (mm)		Length (mm)		Presser Foot	Functions	
		Auto	Manual	Auto	Manual		Reverse	Auto-lock
Utility stitches	01 	3.5	0.0~7.0	2.5	0.0~4.5	T	*	*
	02 	0.0	0.0~7.0	2.5	0.0~4.5	T	*	*
	03 	3.5	0.0~7.0	2.5	1.0~3.0	T	*	*
	04 	3.5	1.0~6.0	2.5	1.0~3.0	T	*	*
	05 	3.5	0.0~7.0	2.5	1.5~3.0	T	*	*
	06 	5.0	0.0~7.0	2.0	0.3~4.5	T	*	*
	07 	5.0	2.0~7.0	1.0	0.3~4.5	T	*	*
	08 	5.0	2.5~7.0	2.5	1.0~3.0	T	*	*
	09 	5.0	3.5~7.0	2.5	1.0~3.0	E	*	*
	10 	5.0	2.5~7.0	2.5	1.0~3.0	T	*	*
	11 	3.5	2.5~7.0	2.0	0.5~4.5	F	*	*
	12 	3.5	2.5~7.0	1.0	0.5~4.5	F	*	*
	13 	3.5	2.5~7.0	2.5	1.5~3.0	T	*	*
	14 	5.0	2.5~7.0	2.5	1.0~3.0	T	*	*
	15 	7.0	2.5~7.0	2.5	1.0~3.0	A	*	*
	16 	5.0	2.5~7.0	2.5	1.0~3.0	A	*	*
Buttonhole stitches	17 	5.0	2.5~7.0	0.5	0.3~1.0	D		
	18 	5.0	2.5~5.5	0.5	0.3~1.0	D		
	19 	7.0	5.5~7.0	0.5	0.3~1.0	D		
Darning stitches	20 	7.0	3.5~7.0	2.0	1.0~2.0	D		
Satin stitches	21 	7.0	2.5~7.0	0.5	0.3~1.0	A	*	*
	22 	7.0	2.5~7.0	0.5	0.3~1.0	A	*	*
	23 	7.0	2.5~7.0	0.5	0.3~1.0	A	*	*
	24 	7.0	2.5~7.0	0.5	0.3~1.0	A	*	*
	25 	7.0	2.5~7.0	0.5	0.3~1.0	A	*	*
Cross stitches	26 	5.0	2.5~7.0	2.5	1.0~3.0	A	*	*
	27 	4.0	3.0~7.0	1.0	1.0~3.0	A	*	*
	28 	6.0	5.0~7.0	1.0	1.0~3.0	A	*	*
Decorative stitches	29 	5.0	3.0~7.0	3.0	1.5~3.0	A	*	*
	30 	7.0	3.0~7.0	2.0	1.0~3.0	T	*	*
	31 	7.0	2.5~7.0	2.0	1.0~3.0	T	*	*
	32 	5.0	2.5~7.0	2.5	1.5~3.0	T	*	*
	33 	7.0	2.5~7.0	1.5	1.0~3.0	A	*	*
	34 	7.0	2.5~7.0	2.5	1.0~4.5	T	*	*
	35 	5.0	3.5~7.0	1.0	1.0~3.0	A	*	*
	36 	7.0	2.5~7.0	3.0	2.0~3.0	A	*	*
	37 	6.0	2.5~7.0	2.0	1.5~3.0	A	*	*
	38 	7.0	2.5~7.0	2.5	1.5~3.0	A	*	*
	39 	5.0	2.5~7.0	2.0	1.0~3.0	T	*	*
40 	5.0	2.5~7.0	2.0	1.0~3.0	T	*	*	

The portion marked in colored on the chart below shows the one unit of each pattern.

Useful skills

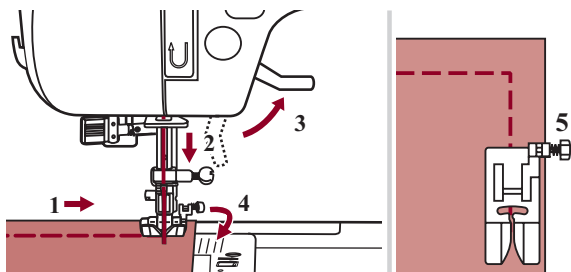

Sewing corners

1. Stop the sewing machine when you reach a corner.
2. Lower the needle into the fabric manually or by pressing the needle up/ down button once.
3. Raise the presser foot.
4. Use the needle as a pivot and turn the fabric.
5. Lower the presser foot and resume sewing.

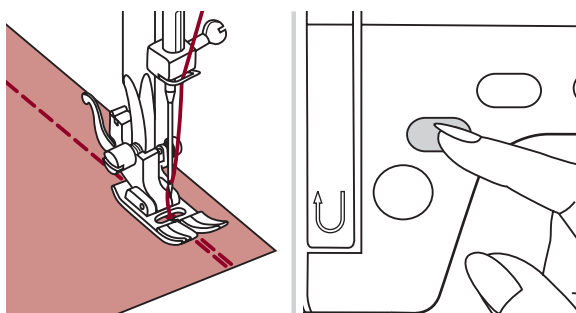

Reverse

Reverse stitching is used to secure the threads at the beginning and at the end of a seam.

Press the reverse button and sew 4-5 stitches. The machine will sew forward when the button is released.

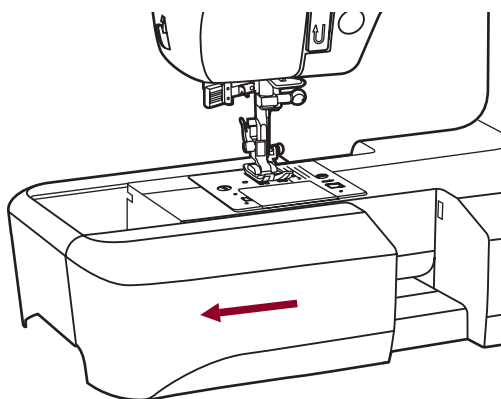

Free arm

Free-arm sewing is convenient for sewing tubular areas such as pant hems and cuffs.

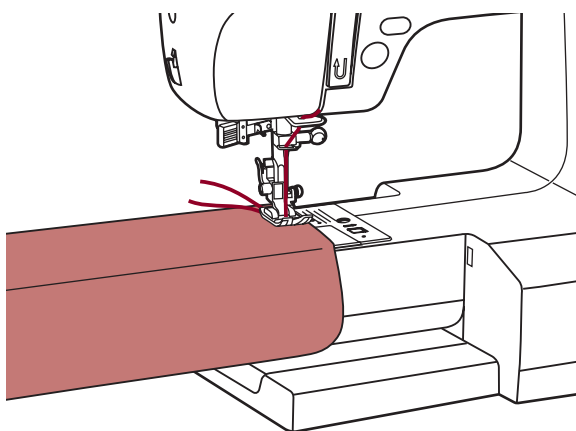

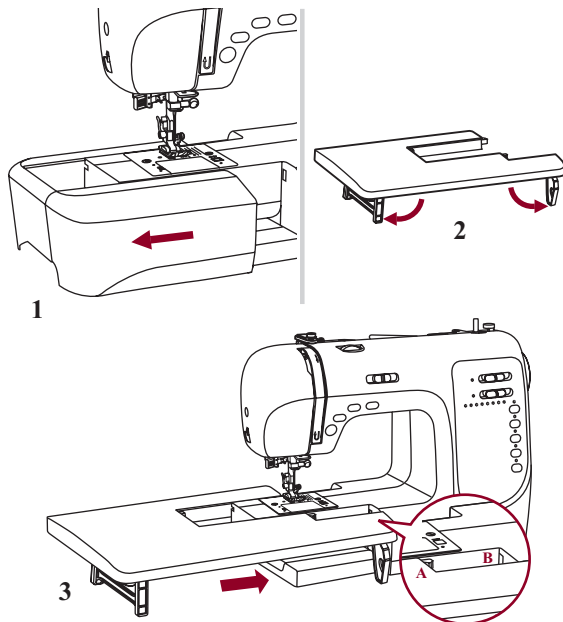

Installing the extension table

* The Extension table accessory is optional. It is not included with this machine.

Pull the sewing table and accessory box off by sliding it to the left. (1)

Follow the arrow, and stretch the foot of the extension table. (2)

Snap (A) of the extension table into (B) of the machine. (3)

Extension table can help moving during sewing.

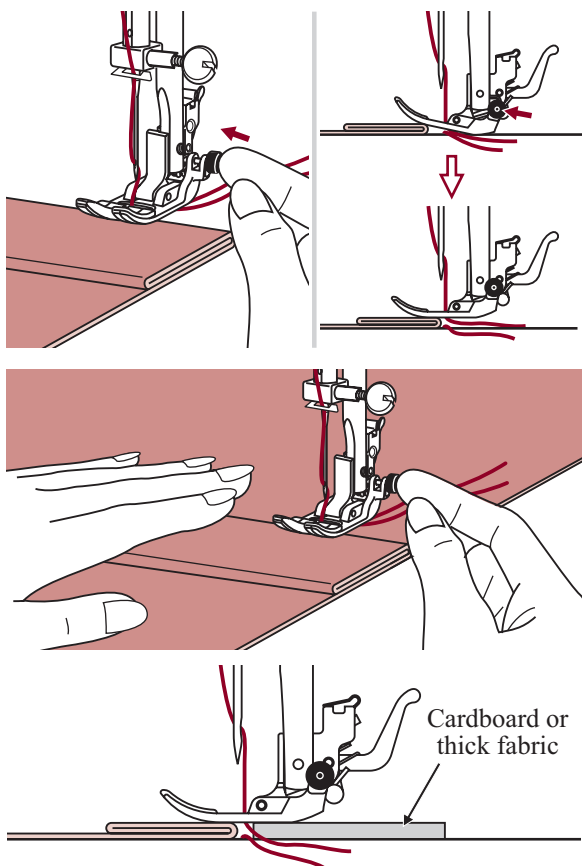

Sewing on the heavy fabric

The black button on the left side of the presser foot will lock the presser foot in a horizontal position if you push it in before lowering the presser foot. This ensures even feeding at the beginning of a seam and helps when sewing multiple layers of fabric such as sewing over seams when hemming jeans.

When you reach the point of an increased thickness, lower the needle and raise the presser foot. Press the toe of the foot and push in the black button, then lower the foot and continue sewing.

The black button releases automatically after sewing few stitches.

You also can place another piece of fabric with the same thickness at the back of the seam. Or support the presser foot while feeding by hand and sewing toward the folded side.

Straight stitches and needle position

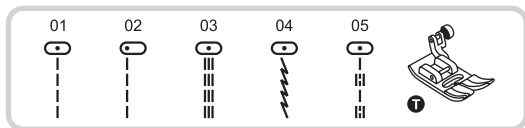

Changing the needle position

These settings apply only to patterns 01-05. The pre-set position is "3.5", center position. When you slide the stitch width adjustment lever to the left, the needle position will move to the left. When you slide the stitch width adjustment lever to the right, the needle position will move to the right.

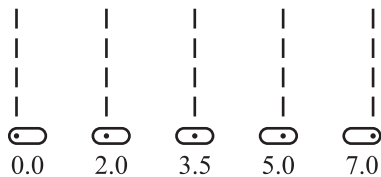

Changing the stitch length

To shorten the stitch length, slide the stitch length adjustment lever to the left. For a longer stitch length, slide the stitch length adjustment lever to the right.

Generally speaking, the thicker the fabric, thread and needle, the longer the stitch should be.

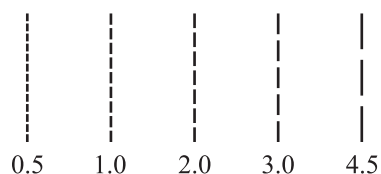

Zigzag stitches

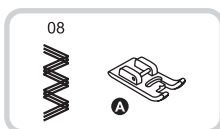
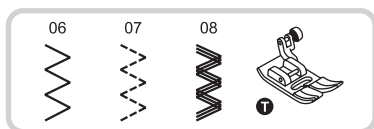

Adjusting the stitch width

The maximum zigzag stitch width for zigzag stitching is "7.0"; however, the width can be reduced on any patterns. The width increases as you slide the stitch width adjustment lever from "0.0-7.0".

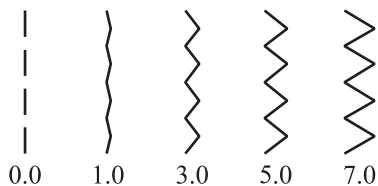

Adjusting the stitch length

The density of zigzag stitches increase as the setting of stitch length approaches "0.3".

Neat zigzag stitches are usually achieved at "1.0-2.5".

Closed up zigzag stitches (close together) are referred to as a satin stitch.

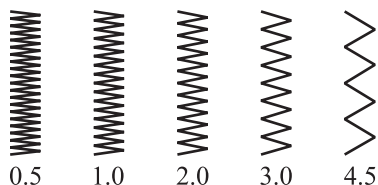

Stretch stitch

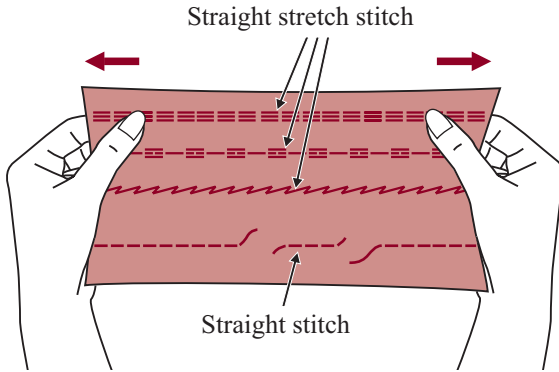
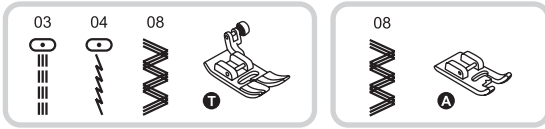

It assures you of a stitch that is strong and flexible and will give with the fabric without breaking. Good for easy to ravel and knit fabrics. It is good for joining durable fabric such as denims.

These stitches can also be used as a decorative top stitch.

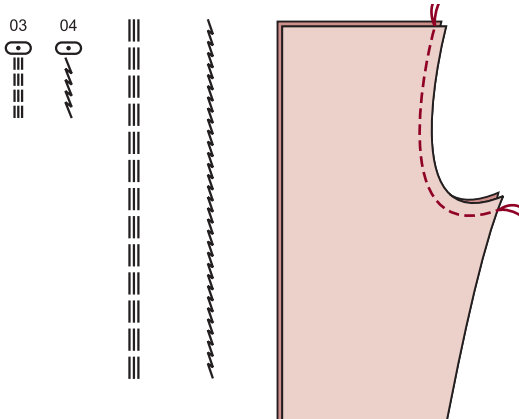

Straight stretch stitch is used to add triple reinforcement to stretch and hardwearing seams.

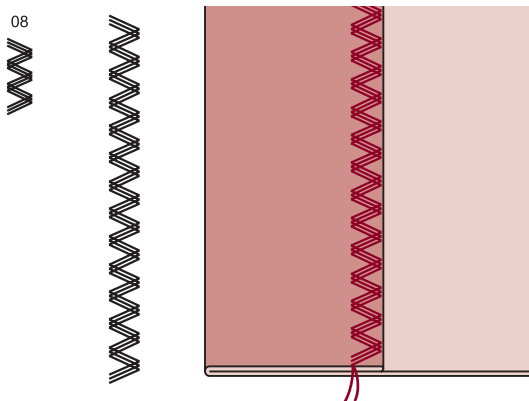

Triple zigzag stretch stitch is suitable for firm fabrics like denim, poplin, duck, etc.

Overcasting stitches

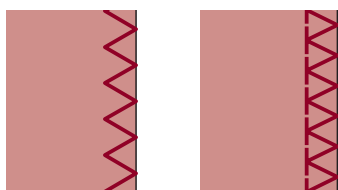
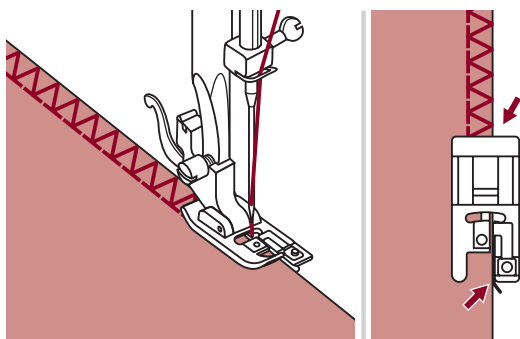

Using the overcasting foot

Change the presser foot to the overcasting foot (E).

Sew the fabric with the fabric edge against the guide of the overcasting foot.

Attention: The overcasting foot should be used to sew with patterns 06 and 09 only and do not set the stitch width narrower than "5.0". It is possible that needle could hit the presser foot and break when sewing other patterns and width.

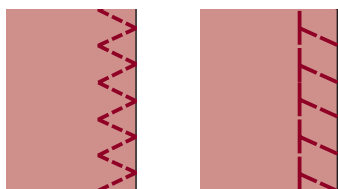
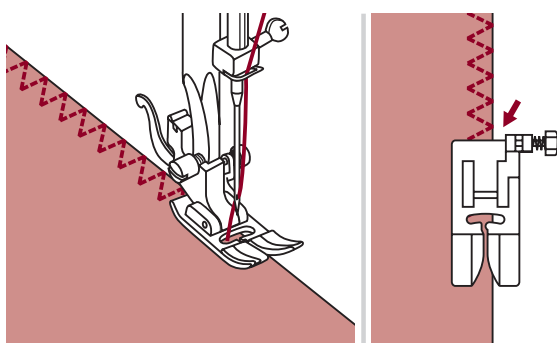

Using the all purpose foot

Change the presser foot to the all purpose foot (T) .

Sewing the overcasting along the edge of the fabric so that the needle drops over the edge of the fabric on the right side.

Blind hem/ Lingerie stitch

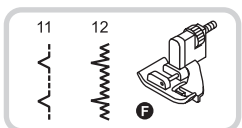

2.5~4.0	1.0~2.0

11: Blind hem/lingerie for firm fabrics

12: Blind hem for stretch fabrics

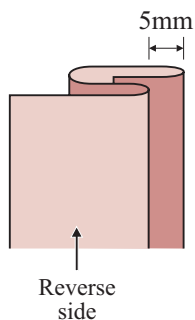
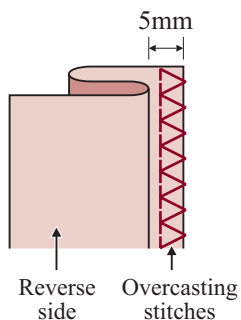

➔ Please Note: It takes practice to sew blind hems. Always make a sewing test first.

Fold the fabric as illustrated with the wrong side uppermost.

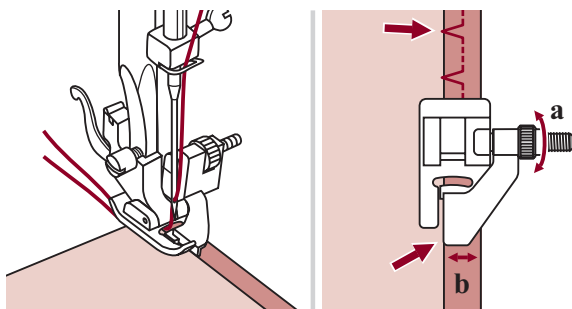

Place the fabric under the foot. Turn the handwheel forwards by hand until the needle swings fully to the left. It should just pierce the fold of the fabric. If it does not, adjust the stitch width accordingly.

Adjust the guide (b) by turning the knob (a) so that the guide just rests against the fold.

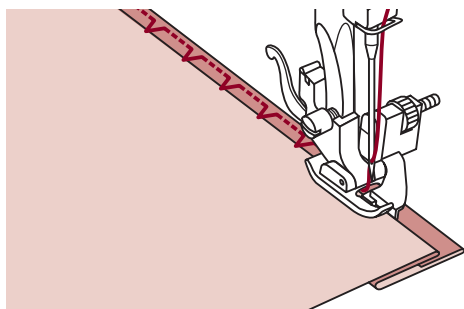

Sew slowly, guiding the fabric carefully along the edge of the guide.

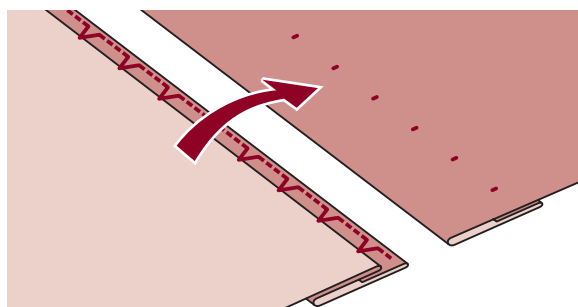

Turn over the fabric.

Button sewing

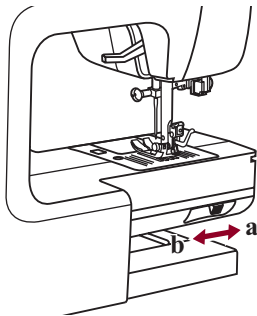
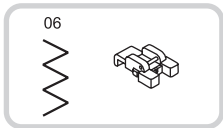

Change the presser foot to the button sewing foot.

Move the drop feed control to " ▼▼ " to lower the feed dogs.

Position the work under the foot. Place the button in the desired position, lower the foot.

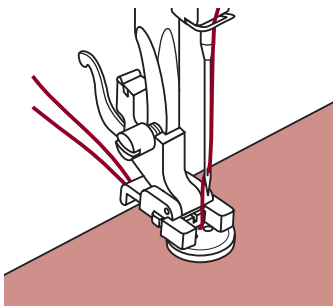

Select zig zag pattern. Adjust the stitch width to "2.5-4.5" according to the distance between the two holes of the button.

Turn the handwheel to check that the needle goes cleanly into the left and right holes of the button.

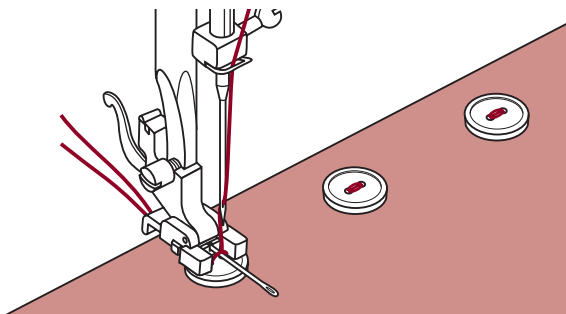

Before sewing, press the Auto-lock button to sew reinforcement stitches automatically at the beginning and at the end of the stitch.

If a shank is required, place a darning needle on top of the button and sew.



For buttons with 4 holes, sew through the front two holes first, push work forward and then sew through the back two holes.

Buttonhole stitching

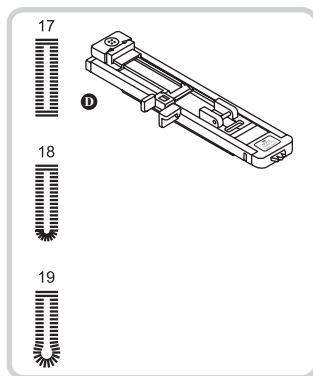

2.5~7.0	0.3~1.0

2.5~5.5	0.3~1.0

5.5~7.0	0.3~1.0

17: For thin or medium fabric

18: For horizontal holes on blouses or shirts made from thin or medium fabric

19: For suits or overcoats

Please Note: Before sewing a buttonhole on your project, practice on a scrap piece of the same type of fabric.

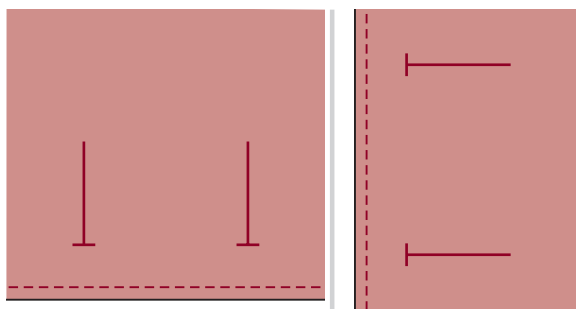

Mark the positions of the buttonhole on the fabric.

The maximum buttonhole length is 3cm (1 3/16 inch). (Total of diameter + thickness of button.)

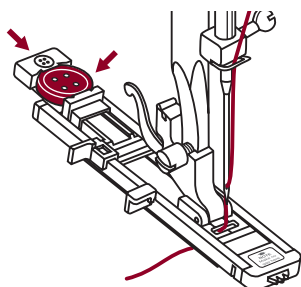

Attach the buttonhole foot, then pull out the button holder plate and insert the button.

The size of the buttonhole is determined by the button inserted in the button plate.

The thread should be passed through the hole in the presser foot, then be placed under the foot.

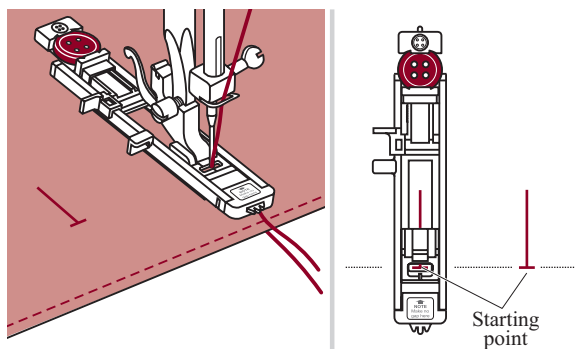

Select the buttonhole stitch.

Adjust the stitch width and the stitch length to the desired width and density.

Position the fabric under the presser foot with the front end of the buttonhole mark aligned with the center line on the buttonhole foot.

Buttonhole stitching

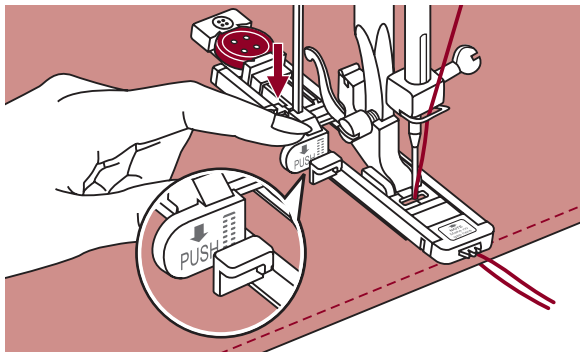

Pull the buttonhole lever all the way down and position it behind the bracket on the buttonhole foot.

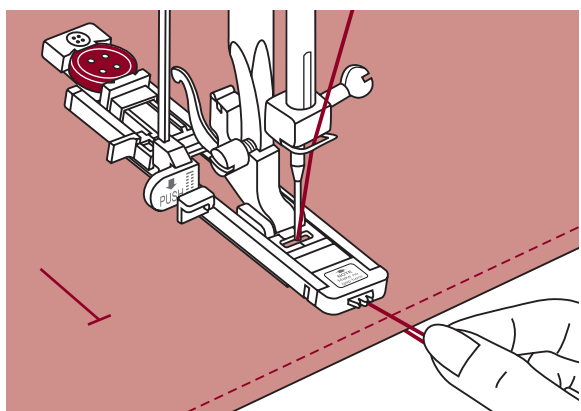

While lightly holding the end of upper thread and start sewing.

➡ Please Note: Gently feed the fabric by hand.
Before stopping, the machine will automatically sew a reinforcement stitch after the buttonhole is sewn.

* Buttonholes are sewn from the front of the presser foot to the back, as shown.

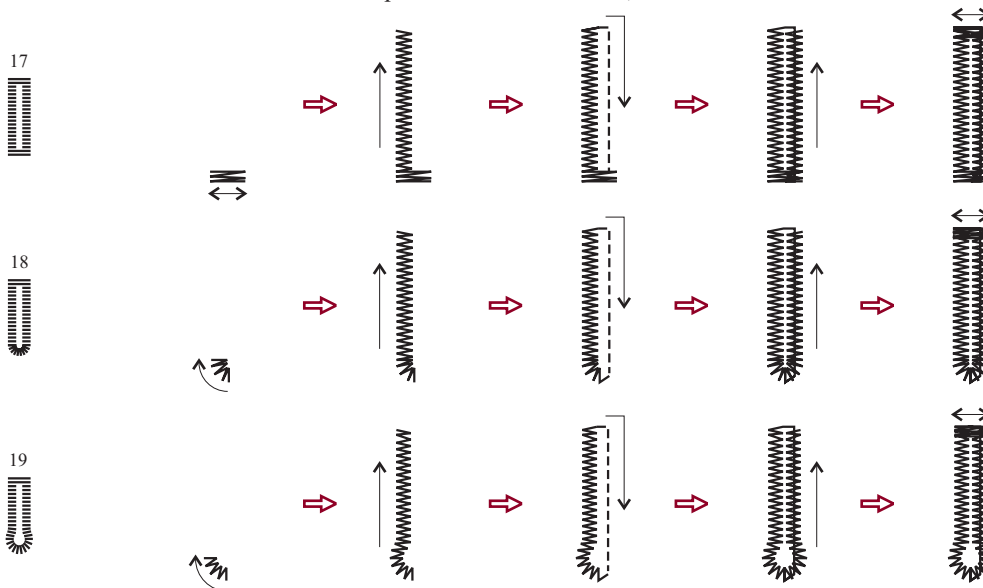

Buttonhole stitching

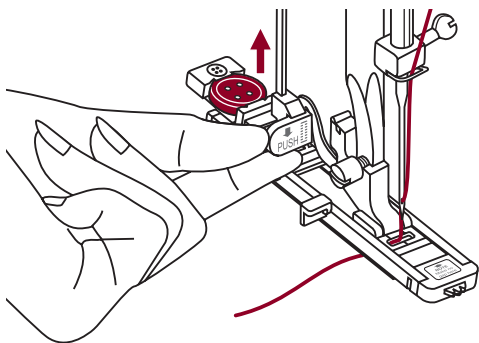

Buttonholes are sewn from the front of the presser foot to the back, as shown.

Raise the presser foot and cut thread. To sew over same buttonhole, raise the presser foot (will return to original position).

After sewing the buttonhole stitch, raise the buttonhole lever until it stops.

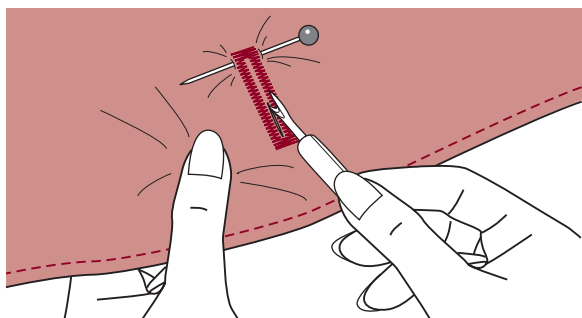

Cut the center of the buttonhole being careful not to cut any stitches on either side. Use a pin as a stopper at the bar tack so you do not cut too much.

Making a buttonhole on stretch fabrics

When sewing buttonholes on stretch fabric, hook heavy thread or cord under the button-hole foot.

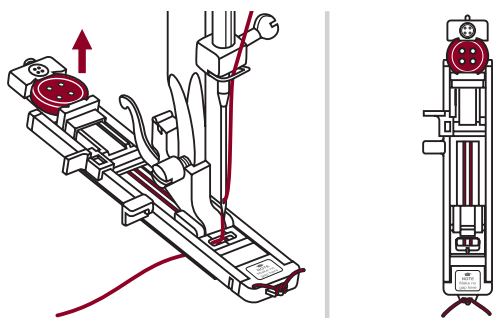

Attach the buttonhole foot and hook the gimp thread onto the back of the presser foot.

Bring the two gimp thread ends to the front of the foot and insert them into the grooves, then temporarily tie them there. Lower the presser foot and start sewing.

Set the stitch width to match the diameter of the gimp thread.

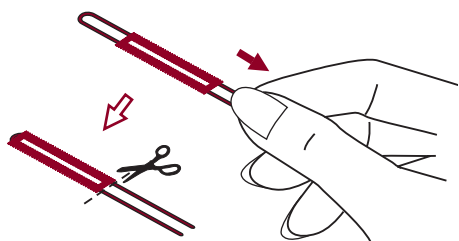

Once sewing is completed, pull the gimp thread gently to remove any slack, then trim off any excess.

Please Note: It is suggested that you use interfacing on the backside of the fabric.

Darning stitch

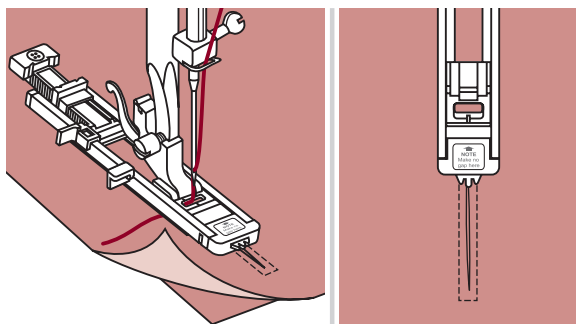

Select pattern 20 to get the darning stitch.
Change the presser foot to the buttonhole foot.

Baste the upper fabric and the under fabric together. Select the needle position. Lower the presser foot over the center of the tear.

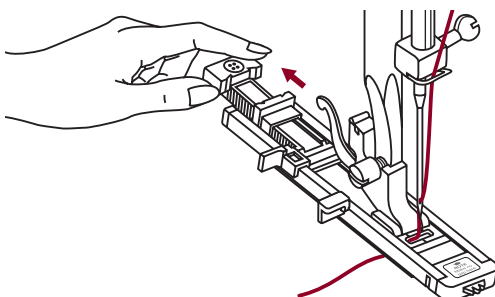

Pull the button holder to rear.
Set the button guide plate on buttonhole foot to the desired length.

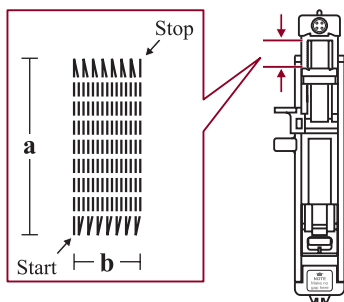

The size of one darn cycle is variable.
However, the maximum stitch length is 2.6cm (1 inch) and the maximum stitch width is 7mm (9/32 inch).

- a. The length of sewing.
- b. The width of sewing.

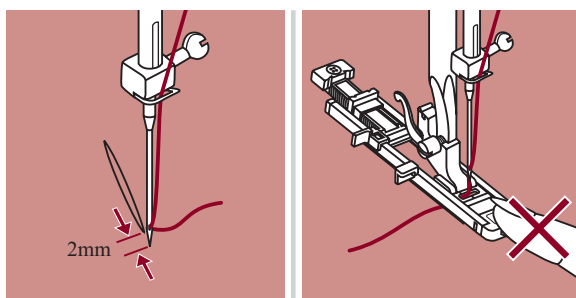

Position the fabric so that the needle is 2mm (1/16 inch) in front of the area to be darned, and then lower the presser foot lever.

➔ Please Note: When lowering the presser foot, do not push in the front of the presser foot, otherwise the darning will not be sewn with the correct size.

Darning stitch

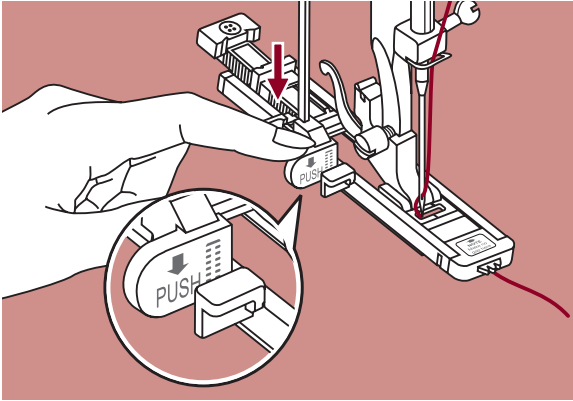

Pass the upper thread down through the hole in the presser foot.
Pull down the buttonhole lever. The buttonhole lever is positioned behind the bracket on the buttonhole foot.

Gently hold the end of the upper thread in your left hand, and then start sewing.

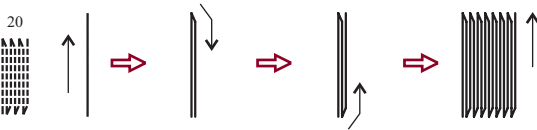

Darning stitches are sewn from the front of the presser foot to the back, as shown.

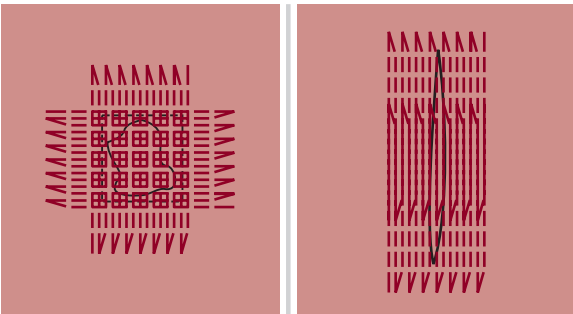

If the sewing range is too big to sew, then we suggest you can sew several times (or cross sew) to get better sewing result.

Zipper insertion

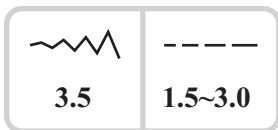
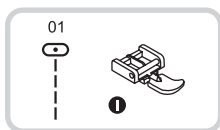

! *Attention: Zipper foot should be used for sewing width center needle position straight stitch only. It is possible that needle could hit the presser foot and break when sewing other patterns.*

Inserting a centered zipper

- Baste the zipper opening on the garment.

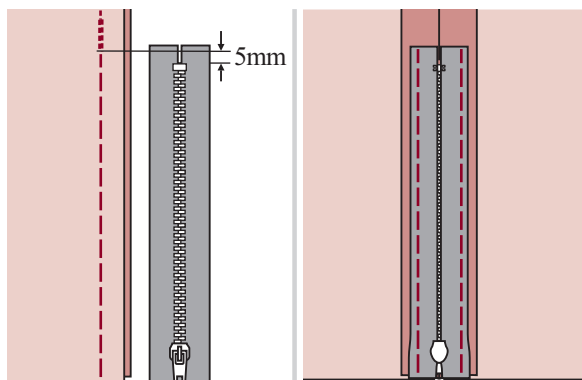

- Press open the seam allowance. Place the zipper face down on the seam allowance with the teeth against the seam line. Baste the zipper tape.

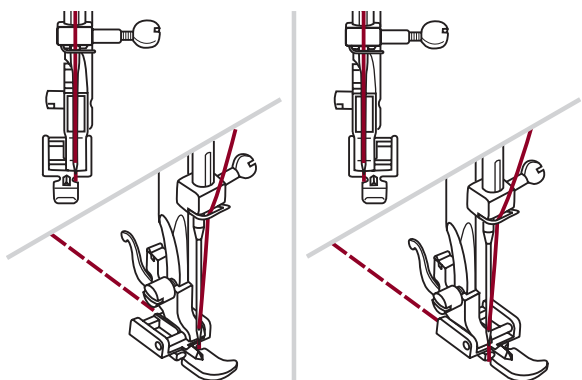

- Attach the zipper foot. Attach the right side of the zipper foot pin to the holder when sewing the left side of the zipper.

- Attach the left side of the zipper foot pin to the zipper foot holder when sewing the right side of the zipper.

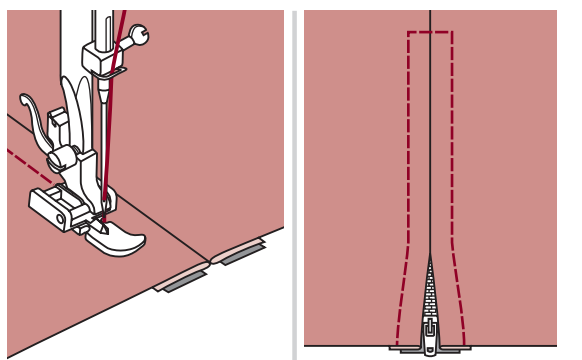

- Stitch left side of the zipper from top to bottom.

- Stitch across the lower end and right side of zipper. Remove the basting and press.

Zipper insertion

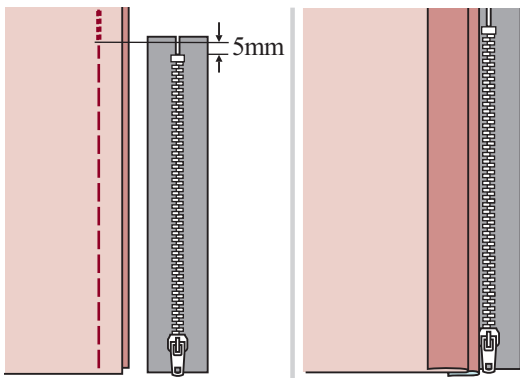

Inserting a side zipper

- Baste the zipper opening on the garment.
- Fold back to the left seam allowance. Turn under the right seam allowance to form 3mm (1/8 inch) fold.

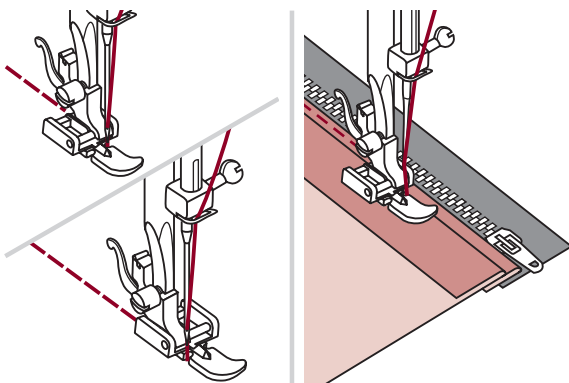

- Attach the zipper foot. Attach the right side of the presser foot pin to the holder when sewing the left side of the zipper. Attach the left side of the presser foot pin to the presser foot holder when sewing the right side of the zipper.

- Stitch the left side of zipper from bottom to top.

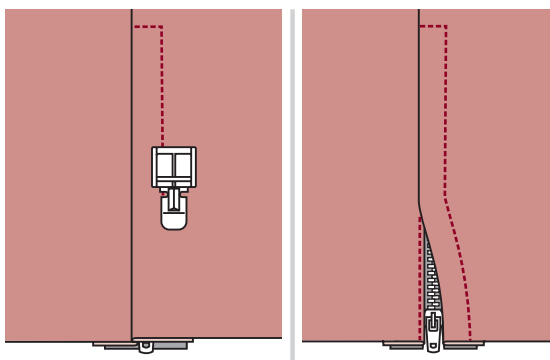

- Turn the fabric right side out, stitch across the lower end and right side of zipper.
- Stop about 5cm (2 inches) from the top of zipper. Remove the basting and open the zipper. Stitch the remainder of the seam.

Narrow hemming

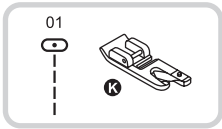

* The Hemmer foot accessory is optional. It is not included with this machine.

Fold edge of fabric over about 3mm (1/8 inch), then fold it over again 3mm (1/8 inch) for about 5cm (2 inches) along the edge of the fabric.

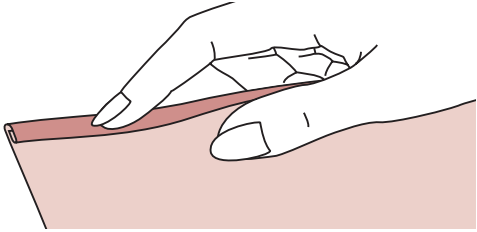

Insert the needle into the fold by rotating the handwheel toward you, and lower the presser foot. Sew several stitches and raise the presser foot.

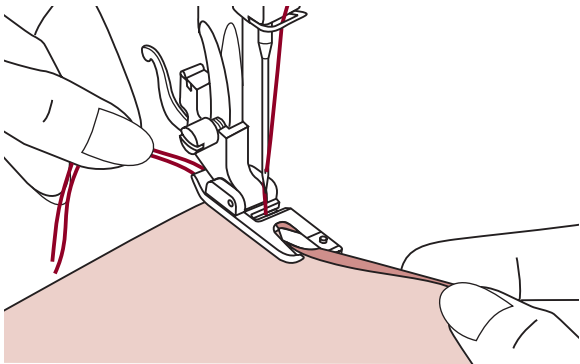

Insert the fabric fold into the spiral opening of hemmer foot. Move fabric back and forth until the fold forms a scroll shape.

Lower the presser foot and start sewing slowly guiding the raw edge of the fabric in front of the hemmer foot evenly into the scroll of the foot.

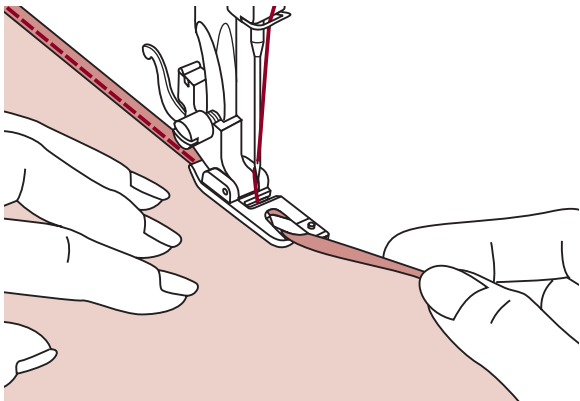

Cording

Sew over one strand of cording to create a pretty swirled design on a jacket or vest or sew over three strands of cording for border trims. Pearl cotton, knitting yarn, embroidery floss, lace thread, fine wool or lily yarn can be used for cording.

* The Cording foot accessory is optional. It is not included with this machine.

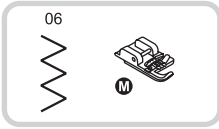

Single cording

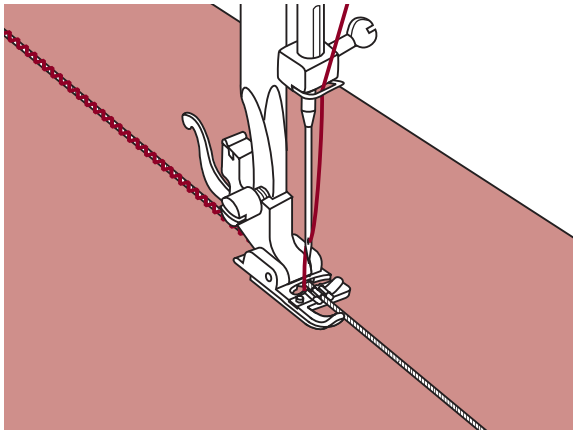

Mark the design on the fabric. Insert the cord in the center groove of the cording foot from the right side opening. Pull the cord about 5cm (2 inches) behind the foot.

The grooves under the foot will hold the length of the cord in place while the stitches are being formed over the cord.

Select the stitch and adjust the stitch width so that the stitches are just covering the cord. Lower the foot and sew slowly, guiding the cord over the design.

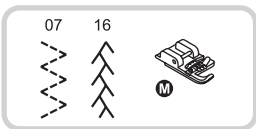

Triple cording

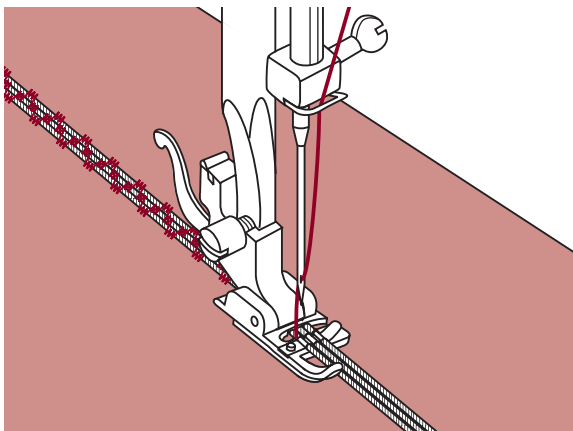

Push the sewing thread to the left and insert three cords into the grooves of the foot and pull about 5cm (2 inches) of the cords behind the foot.

Select the desired pattern and adjust the stitch width so that the stitches are just covering the cords. Lower the foot and sew slowly guiding the cords.

Satin stitch sewing

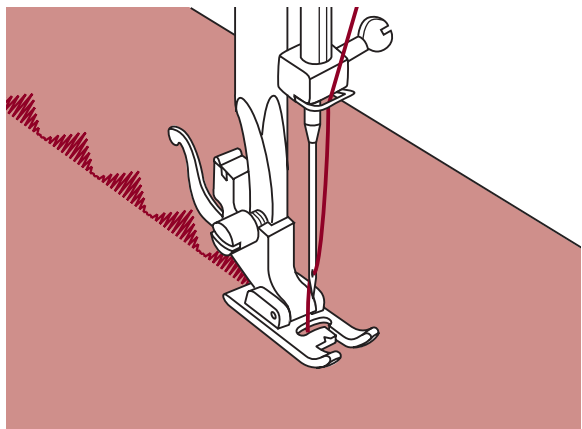
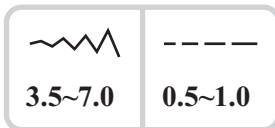
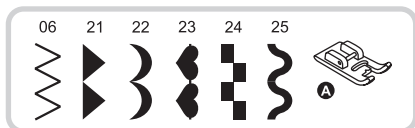

Use the satin stitch foot for satin stitching and sewing decorative stitches. This foot has a full indentation on the underside to allow easy sewing over the thickness of the stitches formed by closely spaced zigzag stitches, and even feeding of the fabric.

To tailor the satin or decorative stitch pattern, you may adjust the length and width of the pattern by pressing the stitch length and width adjustment buttons. Experiment with fabric scraps until you get the desired length and width.

➔ **Please Note:** When sewing very thin fabrics, it is suggested that you use interfacing on the backside of the fabric.

Quilting

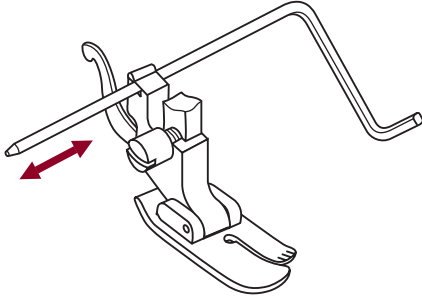
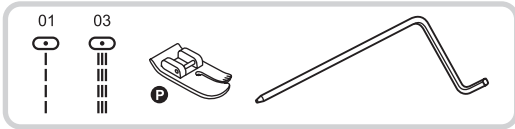

* The Quilting foot accessory is optional. It is not included with this machine.

Insert the edge/quilting guide in the presser foot holder as illustrated and set the space as you desire.

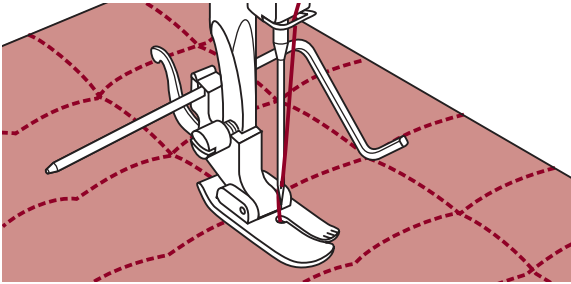

Sew the first row and move over the fabric to sew successive rows with the guide riding along the previous row of stitching.

Scallop stitch

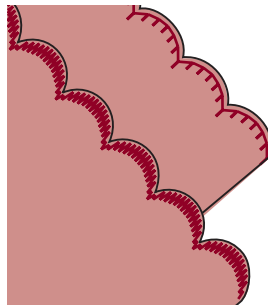
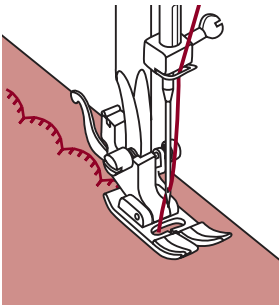
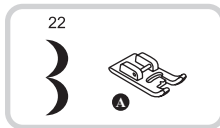
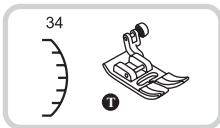

- Stitch along the edge of the fabric, making sure not to sew directly on the edge of the fabric.
For better results, apply spray starch onto the fabric and press with a hot iron before it is sewn.

- Trim along the stitches.
* Be careful not to cut the stitches.

Gathering

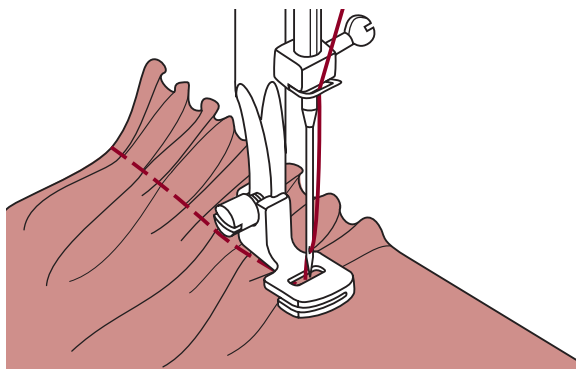

* The Gathering foot accessory is optional. It is not included with this machine.

Gathered fabric

Remove the presser foot holder and attach the gathering foot, lowering the tension setting to below 2.

Place fabric to be gathered under presser foot to the right of the presser foot.

Sew a row of stitching, keeping the raw edge of fabric aligned with the right edge of foot.

The stitches automatically cause the fabric to gather. Suitable for light to medium weight fabrics.

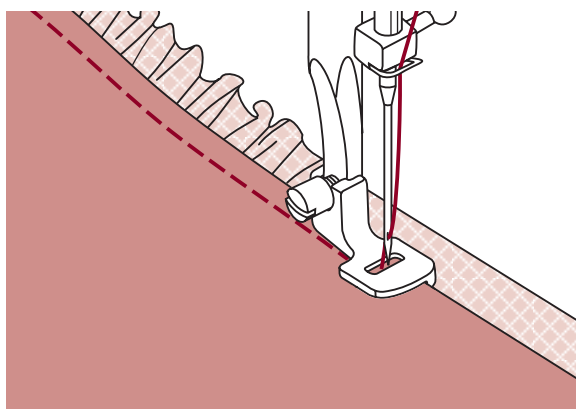

To gather and attach gathered fabric in one step

Look closely at the gathering foot to see a slot on the bottom.

When using the slot, you can gather the bottom layer of the fabric while attaching it to a flat top layer, such as the waistband on a dress bodice.

- Remove the presser foot holder and attach gathering foot.
- Place the fabric to be gathered with right side up under the foot.
- Place top layer of the fabric right side down in the slot.
- Guide the two layers as illustrated.

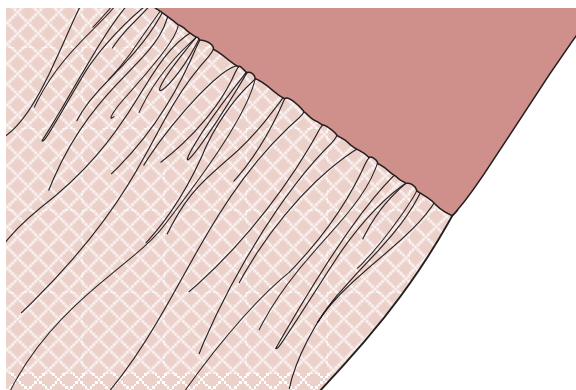

➔ **Note:** When testing machine for adjustments to achieve desired fullness, work with 10" increments of the fabric, trims or elastic. This makes it easier to determine the adjustments and how much change is needed for your project. Always test on your project fabric and on the same grainline as will be used in your finished project.

➔ **Note:** Sew slow to medium speed for better fabric control.

Smocking

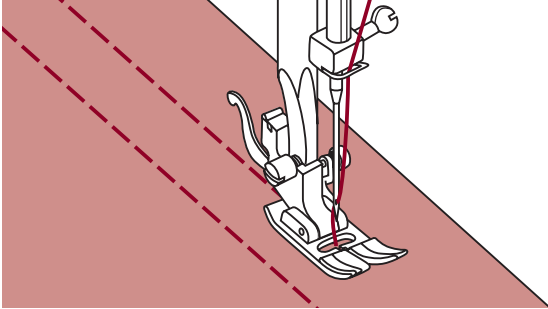
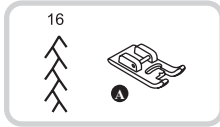
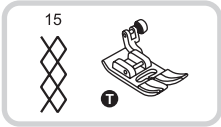

Use the all purpose foot to sew straight lines 1cm (3/8 inch) apart, across the area to be smocked.

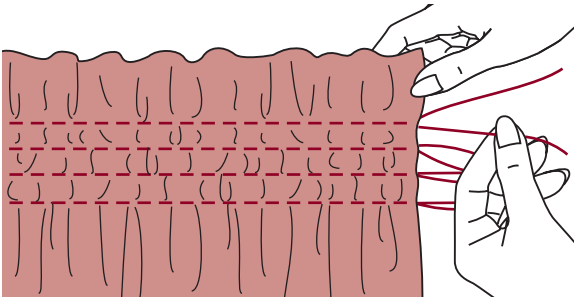

Knot the threads along one edge.
Pull the bobbin threads and distribute the gathers evenly. Secure the threads at the other end.

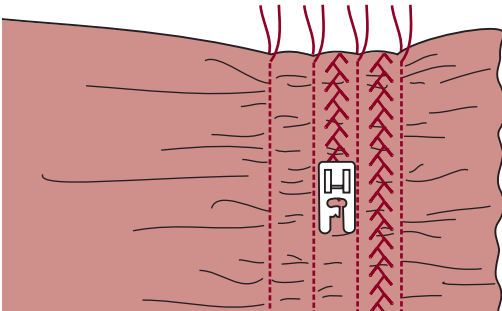

Reduce the tension, if necessary and sew decorative pattern stitches between the straight seams.

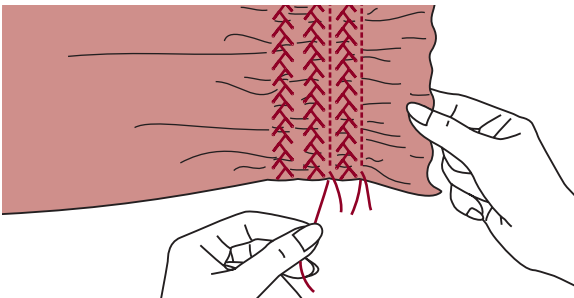

Pull out the gathering stitches.

Free motion darning, embroidery and monogramming

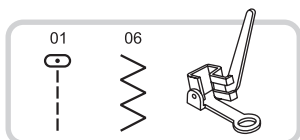

* The Darning/ Embroidery foot accessory is optional. It is not included with this machine.

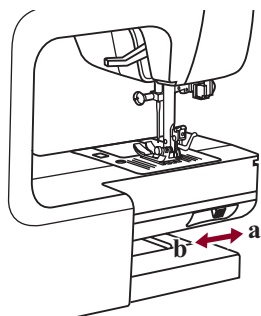

Move the drop feed control to "▼" to lower the feed dogs.

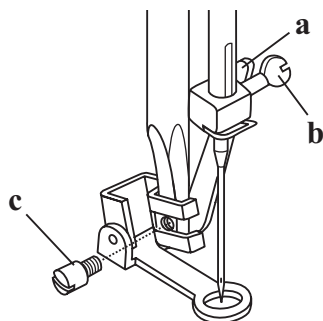

Remove the presser foot holder, and attach the darning foot to the presser foot holder bar.

The lever (a) should be behind the needle clamp screw (b). Press the darning foot on firmly from behind with your index finger and tighten the screw (c).

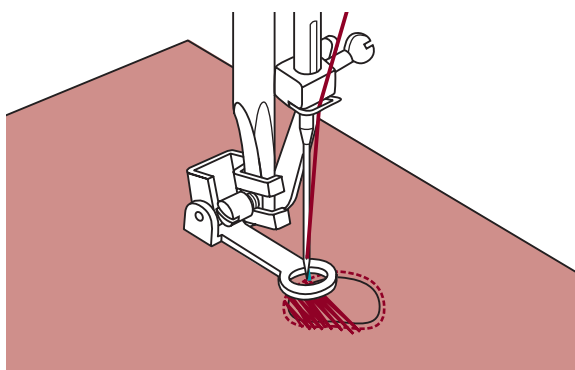

Darning

First sew around the edges of the hole (to secure the threads). Working from left to right, sew over the hole in a constant and continuous movement.

Turn the work by 1/4 and sew over the first stitching moving the work slower over the hole to separate the threads and not form big gaps between the threads.

! Please Note: Free motion darning is accomplished without the sewing machine internal feed system. Movement of the fabric is controlled by the operator. It is necessary to coordinate sewing speed and movement of fabric.

Free motion darning, embroidery and monogramming

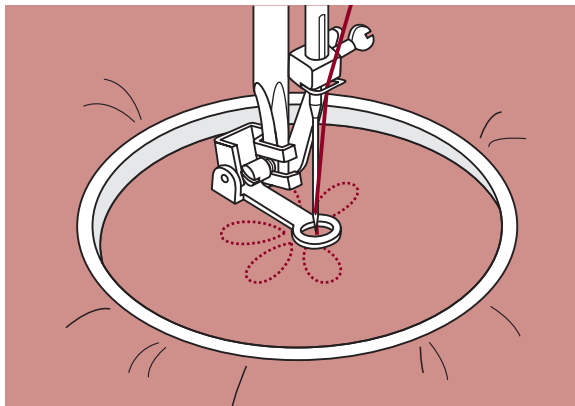

Embroidery

Select zigzag stitch pattern and adjust the stitch width as desired.

Stitch along the outline of the design by moving the embroidery hoop. Make sure to maintain a constant speed.

Fill in the design working from the outline towards the inside. Keep the stitches close together.

You will get longer stitches by moving the hoop faster and shorter stitches by moving the hoop more slowly.

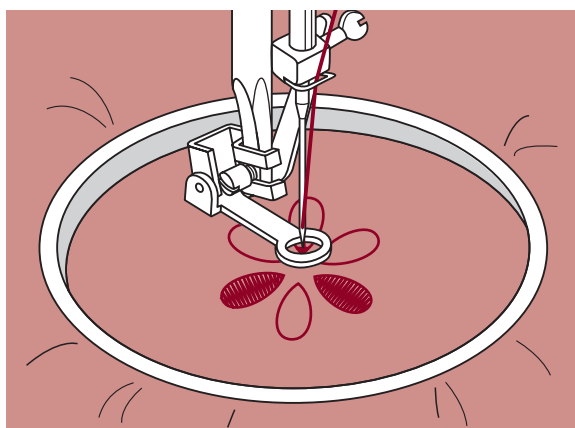

Secure with a reinforcement stitches at the end by press Auto-lock button.

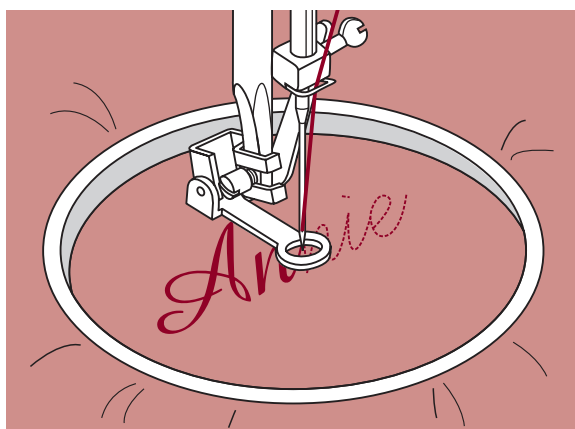

Monogramming

Select the zigzag stitch pattern and adjust the stitch width as desired. Sew at a constant speed, moving the hoop slowly along the lettering.

When the letter is finished. Secure with a reinforcement stitches at the end by press Auto-lock button.

* Embroider hoop is not included with the machine.

Fagoting

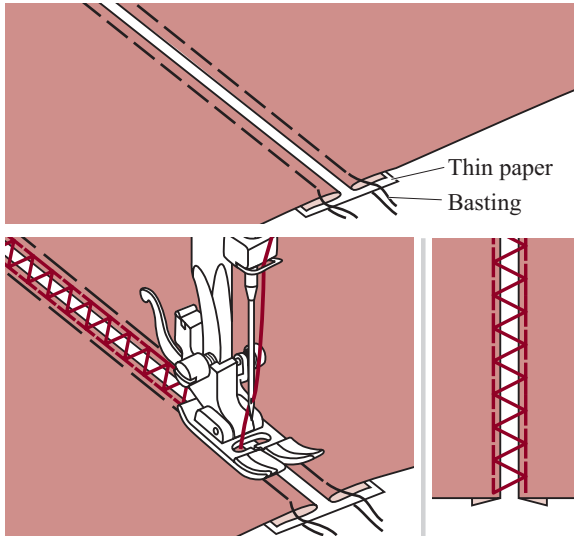
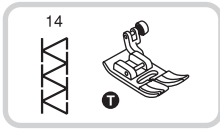

- Separate the folded edges of the fabric pieces with a gap of 4mm (1/8 inch) and baste them onto a piece of thin paper or water-soluble stabilizer sheet.

- Align the center of the presser foot with the center of the two pieces of fabric and begin sewing.

- After sewing, remove the paper.

Patchwork stitching

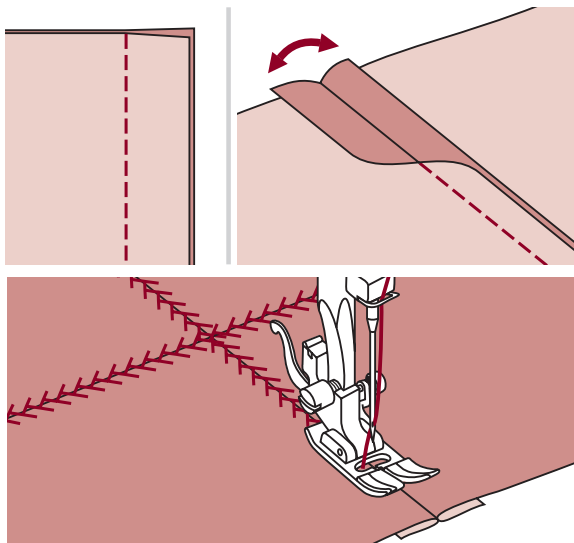
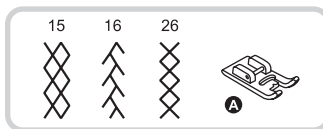
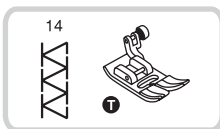

- Place the two pieces of fabric with the right side together and sew with the straight stitch.

- Open the seam allowances and presses it flat.

- Place the center of the presser foot on the seam line of the joined pieces of fabric and sew over the seam.

Twin needle

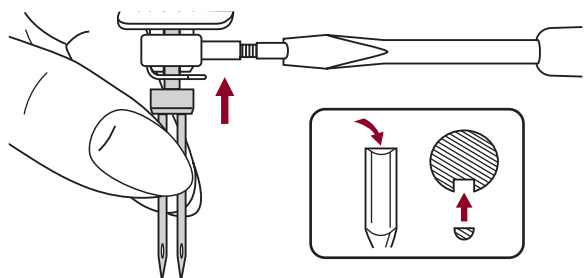

* The twin needle is optional. It is not include with the accessories.

Insert the twin needle.

! Attention: When using twin needles, use the all purpose foot regardless of what kind of sewing foot will be carried out. Use only twin needle assemblies with max. 2mm needle distance.

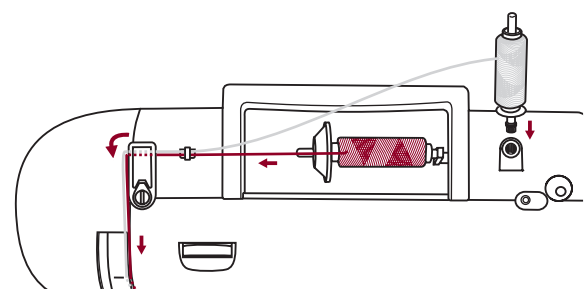

Follow the instructions for single-needle threading using the horizontal spool pin. Thread through the left needle.

Set the second spool pin (included with the accessories) into the hole on the top of the machine. Thread through remaining points, making certain to omit the thread guide above the needle and pass thread through the right needle.

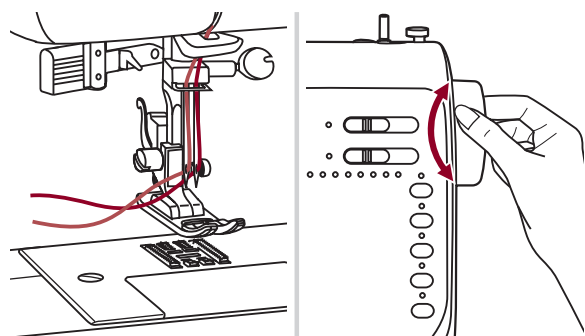

Thread each needle separately.

➔ Please Note: Make sure that the two threads used to thread the twin needle are of the same weight. You can use one or two colors

Before sewing adjust the stitch width, Turn the handwheel to check the needle clearance, so that needle does not hit the needle plate.

When sewing with twin needle, always proceed slowly, and make sure to maintain a low speed to insure quality stitching.

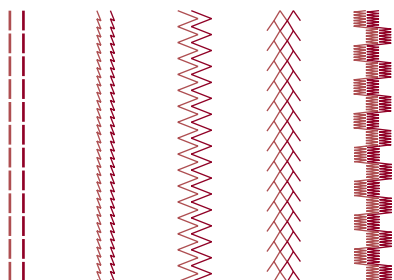

Select a stitch pattern and start to sewing.

Utility and decorative patterns 01-16, 21-40 can be used.

Sewing result will be a pattern with two parallel stitch lines.

➔ Please Note: When sewing with twin needle, always proceed slowly, and make sure to maintain a low speed to insure quality stitching.

Walking foot

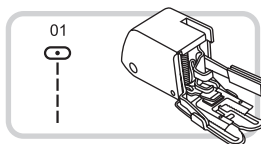

* The walking foot accessory is optional. It is not included with this machine.

Always try to sew first without the walking foot accessory which should be used only when necessary.

It is easier to guide the fabric and you have a better view of the seam when using the standard, regular foot on your machine.

Your sewing machine offers excellent stitch quality on a wide range of fabrics from delicate chiffons to multiple layers of denim.

The Walking Foot accessory equalizes the feeding of the upper and lower layers of fabric and improves the matching of plaids, stripes and patterns. It also helps to prevent uneven feeding of very difficult fabrics. The Walking Foot accessory equalizes the feeding of the upper and lower layers of fabric and improves the matching of plaids, stripes and patterns. It also helps to prevent uneven feeding of very difficult fabrics.

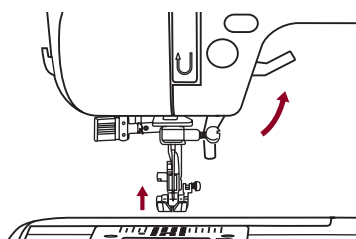

Lift the presser foot lifter to raise the presser foot bar.

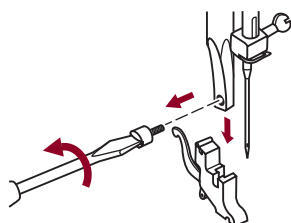

Remove the presser foot holder by unscrewing (counterclockwise) the presser bar attaching screw.

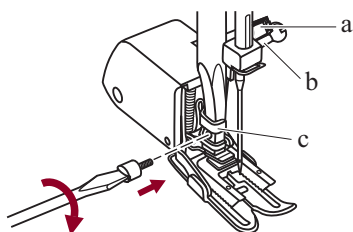

Attach the Walking Foot to the machine as follows:

- The arm (a) should fit into above the needle screw and clamp (b).
- Slide the plastic attaching head (c) from your left to right so that it is fitted into the presser foot bar.
- Lower the presser foot bar.
- Replace and tighten (clockwise) the presser bar attaching screw.
- Make sure both the needle screw and the presser bar attaching screw are tightly secured.

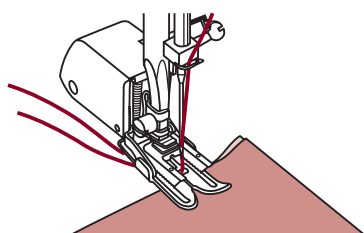

Draw the bobbin thread up and place both the bobbin thread and the needle thread behind the walking foot attachment.

Warning functions

Warning beeping sound

- When operating correctly: 1 beep
- When operating incorrectly: 3-short beeps
- When the sewing machine is in trouble and can't sew: 3-short beeps

It means that the thread is twisted or jammed and the hand wheel axle can't move. Please look through the "Trouble shooting guide" on page 48/49 to find the solution. After the problem has been solved, the machine will continue to sew.

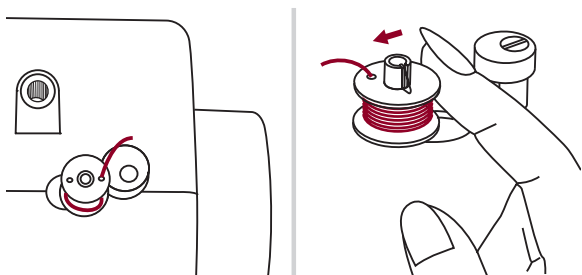

Return bobbin winder spindle to left

If you press any button on the machine when the bobbin is full or the bobbin winder spindle is in the right position, then the machine will beep 3 times as a warning.

Return the bobbin winder spindle to the left position.

 **Please Note:** If the problem is still not solved, please contact your local dealer.

 **Attention:** During the sewing, if the thread get jammed inside the hook stopping the needle from moving and you continue pressing the foot control, the security switch will stop the machine completely. In order to restart the sewing machine, you will have to turn the on/off switch to the OFF position and then ON again.

Maintenance

Cleaning the sewing machine surface

If the surface of the sewing machine is dirty, lightly soak a cloth in mild detergent, squeeze it out firmly and then wipe the surface. After cleaning it once in this way, wipe the surface again with a dry cloth.

 **Attention:** This machine is equipped with a 100mW LED lamp. If lamp replacement is needed, please contact nearest authorized retailer.

Cleaning the hook

If lint and bits of thread accumulate in the hook, this will interfere with the smooth operation of the machine. Check regularly and clean the stitching mechanism when necessary.

 **Attention:** Disconnect the machine from the wall outlet before carrying out any maintenance.

Maintenance

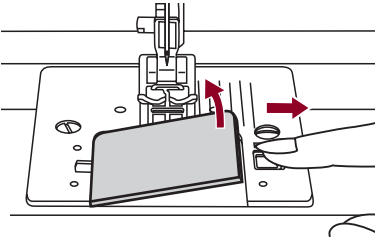

Remove the needle plate cover and bobbin.

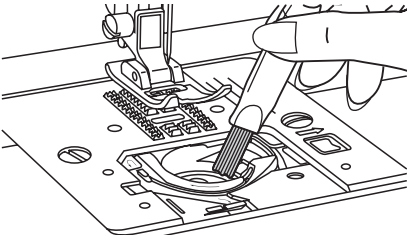

Clean the bobbin holder with a brush.

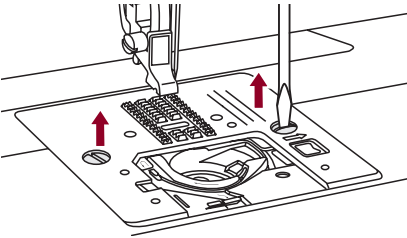

Remove the needle, presser foot and presser foot holder.

Remove the bobbin cover plate and bobbin.

Remove the screw holding the needle plate and remove the needle plate.

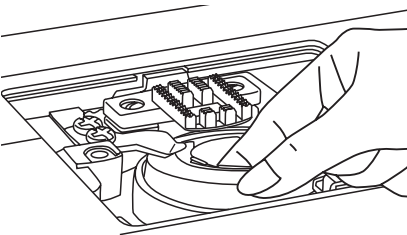

Lift up the bobbin case and remove it.

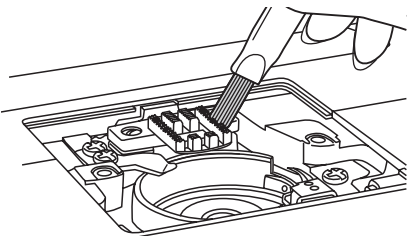

Clean the hook race, feed dog and bobbin case with a brush. Also clean them, using a soft, dry cloth.

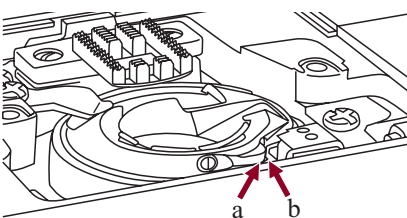

Replace the bobbin case into the hook race so that the tip (a) fits to the stopper (b) as shown.

Trouble shooting guide

Before calling for service, check the following items. If the problem still persists, contact the place of purchase or your nearest authorized dealer.

Problem	Cause	Correction	Reference
Upper thread breaks	1. The machine is not threaded correctly.	1. Rethread the machine.	Page 11
	2. The thread tension is too tight.	2. Reduce the thread tension (lower number).	Page 14
	3. The thread is too thick for the needle.	3. Select a larger needle.	Page 7
	4. The needle is not inserted correctly.	4. Remove and reinsert the needle (flat side towards the back).	Page 7
	5. The thread is wound around the spool holder pin.	5. Remove the reel and wind thread onto reel.	Page 11
	6. The needle is damaged.	6. Replace the needle.	Page 7
Lower thread breaks	1. The bobbin case is not inserted correctly.	1. Remove and reinsert the bobbin case and pull on the thread. The thread should pull easily.	Page 10
	2. The bobbin case is threaded wrong.	2. Check both bobbin and bobbin case.	Page 10
	3. The lower thread tension is too tight	3. Loosen lower thread tension as described.	Page 20
Skipped stitches	1. The needle is not inserted correctly.	1. Remove and reinsert needle (flat side towards the back).	Page 7
	2. The needle is damaged.	2. Insert a new needle.	Page 7
	3. The wrong size needle has been used.	3. Choose a needle to suit the thread.	Page 7
	4. The foot is not attached correctly.	4. Check and attach correctly.	Page 5
	5. The machine is not threaded correctly.	5. Rethread the machine.	Page 11
Needle breaks	1. The needle is damaged.	1. Insert a new needle.	Page 7
	2. The needle is not correctly inserted.	2. Insert the needle correctly (flat side towards the back).	Page 7
	3. Wrong needle size for the fabric.	3. Choose a needle to suit the thread and fabric.	Page 7
	4. The wrong foot is attached.	4. Select the correct foot.	Page 20
	5. The needle clamp screw is loose.	5. Use the screwdriver to firmly tighten the screw.	Page 7
	6. The presser foot that is used is not appropriate for the type of stitch that you wish to sew.	6. Attach the presser foot that is appropriate for the type of stitch that you wish to sew.	Page 20
	7. The upper thread tension is too tight.	7. Loosen the upper thread tension.	Page 14
Loose stitches	1. The machine is not correctly threaded.	1. Check the threading.	Page 11
	2. The bobbin case is not correctly threaded.	2. Thread the bobbin case as illustrated.	Page 10
	3. Needle/ fabric/ thread combination is wrong.	3. The needle size must suit the fabric and thread.	Page 7
	4. Thread tension is wrong.	4. Correct the thread tension.	Page 14
Seam gather or pucker	1. The needle is too thick for the fabric.	1. Select a finer needle.	Page 7
	2. The stitch length is adjusted wrong.	2. Readjust the stitch length.	Page 18
	3. The thread tension is too tight.	3. Loosen the thread tension.	Page 14

Trouble shooting guide

Problem	Cause	Correction	Reference
Seam puckering	1. The needle thread tension is too tight.	1. Loosen the thread tension.	Page 14
	2. The needle thread is not threaded correctly.	2. Rethread the machine.	Page 11
	3. The needle is too heavy for the fabric being sewn.	3. Choose a needle to suit the thread and fabric.	Page 7
	4. The stitch length is too long for the fabric.	4. Make stitch dense.	Page 18
Patterns are distorted	1. The correct presser foot is not used.	1. Select the correct foot.	Page 20
	2. The needle thread tension is too tight.	2. Loosen the thread tension .	Page 14
The machine jams	1. Thread is caught in the hook.	Remove the upper thread and bobbin case, turn the handwheel backwards and forwards by hand and remove the thread remnants.	Page 46
	2. The feed dogs are packed with lint.		
The machine is noisy	1. Fluff or oil have collected on the hook or needle bar.	1. Clean the hook and feed dog as described.	Page 46
	3. The needle is damaged.	3. Replace the needle.	Page 7
	4. Slight humming sound coming from internal motor.	4. Normal.	--
	5. Thread is caught in the hook.	Remove the upper thread and bobbin case, turn the handwheel backwards and forwards by hand and remove the thread remnants.	Page 46
	6. The feed dogs are packed with lint.		
Uneven stitches, uneven feed	1. Poor quality thread.	1. Select a better quality thread.	Page 7
	2. The bobbin case is threaded wrong.	2. Remove the bobbin case, the thread and reinsert correctly.	Page 10
	3. Fabric has been pulled.	3. Do not pull on the fabric while sewing, let it be taken up by the machine.	--
The sewing machine doesn't operate	1. The machine is not turned on.	1. Turn on the machine.	Page 3
	2. The presser foot lever is raised.	2. Lower the presser foot lever.	Page 16
	3. The machine is not plugged in.	3. Connect the power line plug to the electric outlet.	Page 3



Do not dispose of electrical appliances as unsorted municipal waste, use separate collection facilities. Contact your local government for information regarding the collection systems available. If electrical appliances are disposed of in landfills or dumps, hazardous substances can leak into the groundwater and get into the food chain, damaging your health and well-being. When replacing old appliances with new ones, the retailer is legally obligated to take back your old appliance for disposal at least for free of charge.