



# KNITTING MANUAL

SK 840

# CONTENTS

	page
TAKING A TENSION GAUGE .....	1
Tension gauge .....	1
To knit a tension swatch .....	1
When you knit with very thick yarn .....	3
When the Ribber is used .....	4
Gauge Scale .....	5
How to measure the tension swatch .....	5
KNITTING TECHNIQUES —on the knitter— .....	6
Decreasing 1 stitch .....	6
Fully fashioned decrease .....	6
Increasing 1 stitch .....	7
Fully fashioned increase .....	7
Decreasing multiple stitches .....	8
Increasing multiple stitches using Main Carriage .....	8
Increasing multiple stitches using the Lace Carriage .....	9
PARTIAL KNITTING .....	10
Decreasing stitches using the Main Carriage .....	10
Decreasing stitches using the Lace Carriage .....	11
Increasing stitches using the Main Carriage .....	12
Increasing stitches using the Lace Carriage .....	13
K1.P1. Rib .....	14
Mock Rib .....	16
Cast-on by winding yarn .....	17
Picot Hem .....	18
Holding stitches .....	19
In D position (Main Carriage only) .....	19
Using Ravel Cord .....	19
Waste yarn I (Main Carriage only) .....	20
Waste yarn II (for Lace Carriage) .....	20
To put yarn mark .....	21
To cast off with Transfer Tool .....	21
To cast off using Back Stitch method .....	22
To cast off with Tappet Tool .....	24
Trimming .....	25
Buttonhole by transferring stitches .....	26
Buttonhole by hand work .....	27
Seaming on the machine .....	28
Stitches to stitches .....	28
Open stitches to side edge .....	28
Joining by hand .....	29
Blind stitch .....	29
Grafting .....	30
Slip stitch .....	30
Sew in yarn ends .....	31
Cord knitting .....	31
Cable pattern .....	32
Garter stitch .....	32
Blocking and pressing .....	33
IF MISTAKE OCCUR DURING KNITTING .....	34
OPTIONAL ATTACHMENTS .....	35
Design Controller, PE1 .....	35
Knit Contour .....	35

# TAKING A TENSION GAUGE

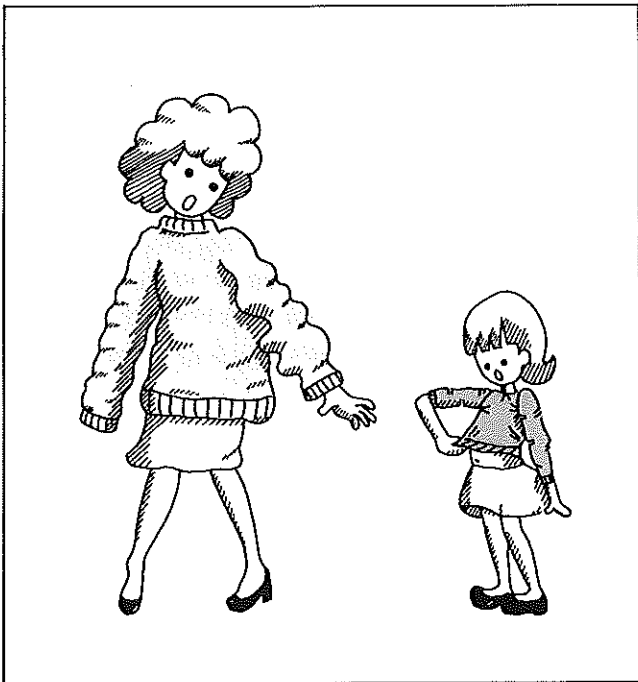

## Tension gauge

Tension gauge indicates how many stitches you need to cast-on, and how many rows you need to knit to make a 10cm. square. It is very important to take a correct tension gauge to knit a garment in your desired size.

To take a correct tension gauge, the tension swatch must be knitted in the same stitch pattern, with the same yarn and Stitch Dial as to be used for the garment.

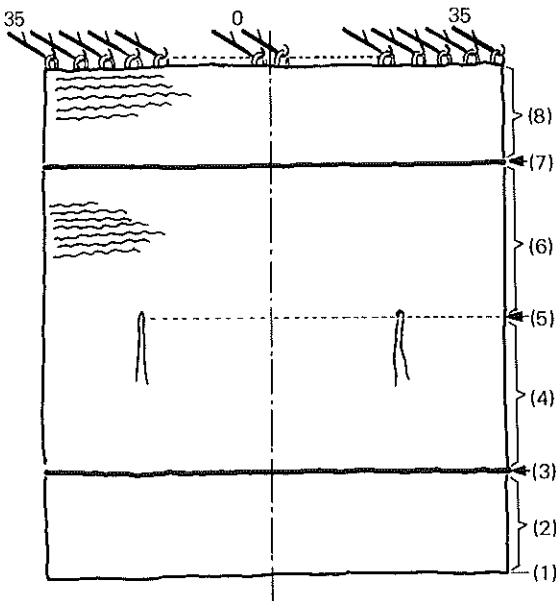

## To knit a tension swatch

Prepare the yarn you selected and a small amount of contrasting colour yarn for marking the swatch.

Decide on the Stitch Dial number referring to page 5 in the Operation Manual. It is recommended that you try different Stitch Dial settings till you obtain a suitable tension for the yarn and stitch pattern chosen.

Knit the swatch as instructed below.

The method below is for knitting a tension swatch in Stockinet, but if you knit the swatch in a pattern stitch using a Pattern Card, follow the additional instructions given after  mark as well.

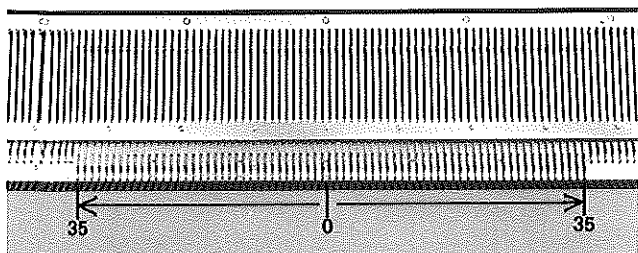

- (1)  Press "ON" the Inspection Switch and set the selected Pattern Card. Set the Pattern Width Indicator.

Push 35 needles on both sides of the centre(0) to B position, 70 needles altogether.

-  Set the Needle-1 Cam and the Point Cams.

Cast on with main yarn.

For the lace pattern, knit about 30 rows in Stockinet ending with the Carriage at the right side of the knitting. Hook the Wide Claw Weights.

-  Press "OFF" the Inspection Switch.

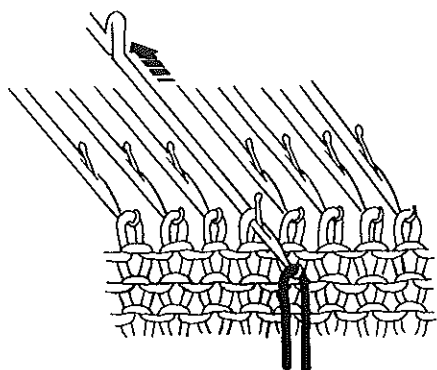

(2) Knit 20 rows in selected stitch pattern, with the selected Stitch Dial number.

(3) Change to the contrast yarn, and knit 2 rows in Stockinet.

(4) Remove contrast yarn and rethread the main yarn. Knit 30 rows in selected stitch pattern with the selected Stitch Dial setting.

(5) Push the 21st needles on either side of centre(0) to D position and place a piece of contrast yarn in each of the needle hooks. Push the needles back to B position.

If the needle has an incomplete loop in lace pattern, put the yarn mark on the stitch of previous row.

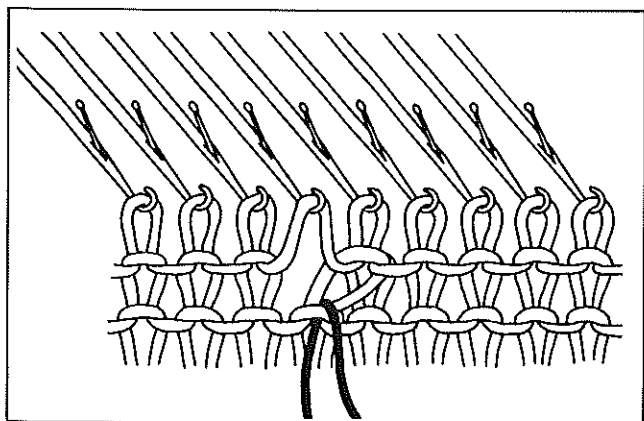

(6) Knit another 30 rows.

(7) Thread the contrast yarn and knit 2 rows in Stockinet.

(8) With main yarn, knit 20 rows in selected stitch pattern with the selected Stitch Dial setting.

Remove the yarn from the Yarn Feeder.  
Set the Cam Lever to Stockinet.  
Remove the swatch from the machine.

**MAKE A NOTE OF THE STITCH DIAL NUMBER.**

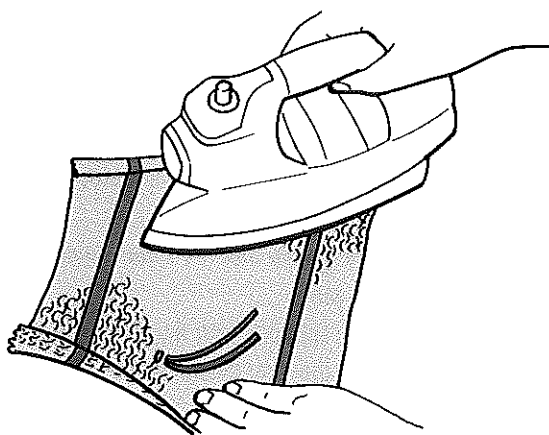
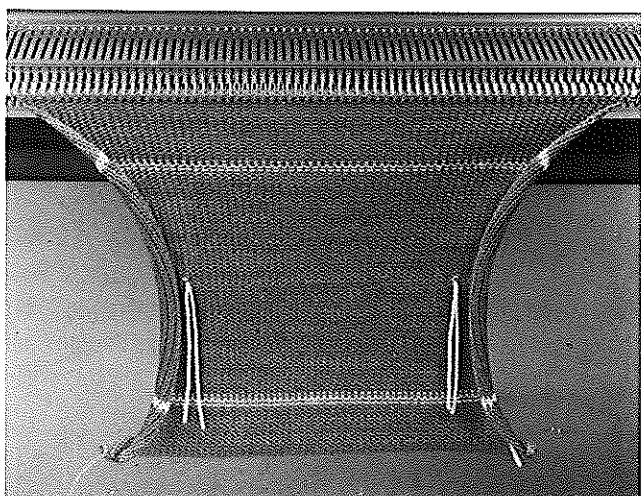

Allow the swatch to rest for several hours, to return to its natural condition, after being stretched on the machine. Press lightly with a steam iron, or with an ordinary iron over a damp cloth. Allow to dry before taking tension gauge.

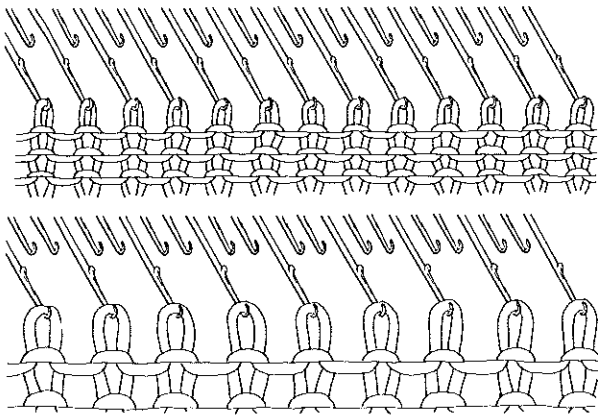

### When you knit with very thick yarn...

Every other or every third needle selection is required for very thick yarn.

Take care to select Pattern Card for pattern knitting.

Knit the tension swatch (e.g. every other needle selection) in the manner instructed below.

1. Push 35 needles on both sides of the centre(0) to B position, and push every other needle back to A position using the 1/1 Needle Pusher, so as the needles are arranged as shown below.

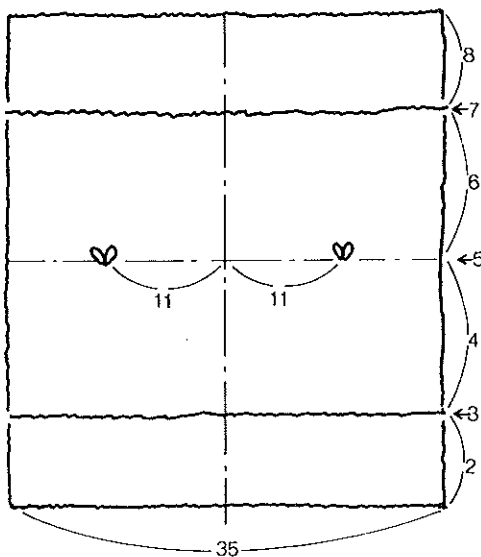
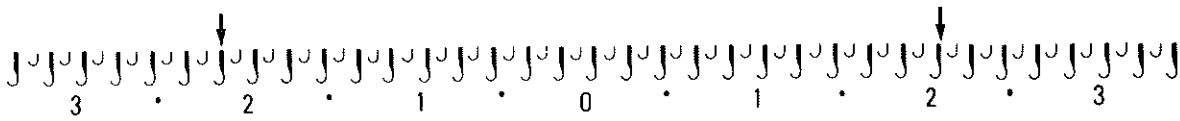

2. With the main yarn, cast-on and knit continuously checking tension on the knitting, till you obtain suitable Stitch Dial number. Knit 10 rows.
3. With a contrast yarn, knit 2 rows in Stockinet.
4. With the main yarn, knit 15 rows.
5. Push the 11th needle on both sides of the centre(0), marked by arrows as shown above to D position. Lay a contrast yarn in the needle hooks, and push them back to B position.
6. Knit another 15 rows continuously with the main yarn.
7. With the contrast yarn, knit 2 rows in Stockinet.
8. With the main yarn, knit another 10 rows.

### TAKE NOTE OF THE STITCH DIAL NUMBER.

Remove the swatch from the machine.

Roll the tension piece into a tube, from side to side, and pull it lengthways. This allows the stitches to go back into shape after having been stretched across the machine needles.

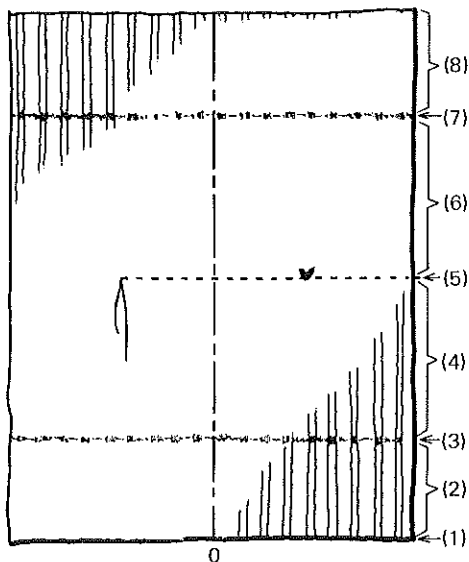

### When the Ribber is used

The following instructions should be used when knitting the tension swatch and also taking a tension gauge.

(1) Regardless of stitch type, always arrange needles between 35th needles on both sides of centre(0) on both beds.

(2) Cast-on and knit 20 rows.

(3) With contrast yarn, knit 2 rows.

(4) With main yarn, knit 30 rows.

(5) Put yarn marks on the 21st needles on both sides of centre(0) on either Knitter or Ribber.

(6) Knit 30 rows.

(7) With contrast yarn, knit 2 rows.

(8) With main yarn, knit 20 rows.

(9) Remove the swatch from the machine.

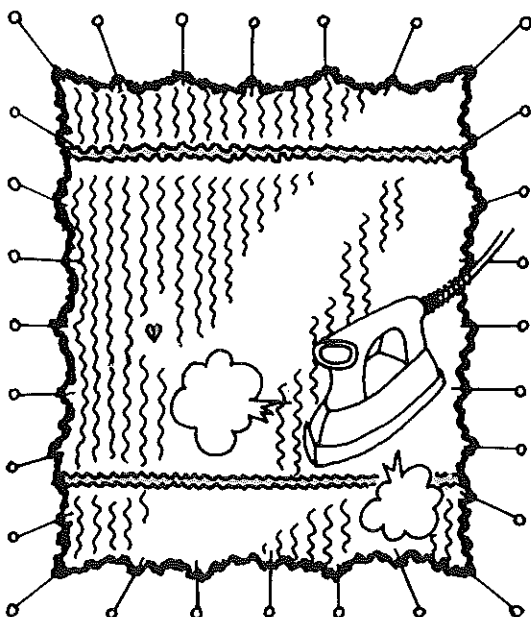
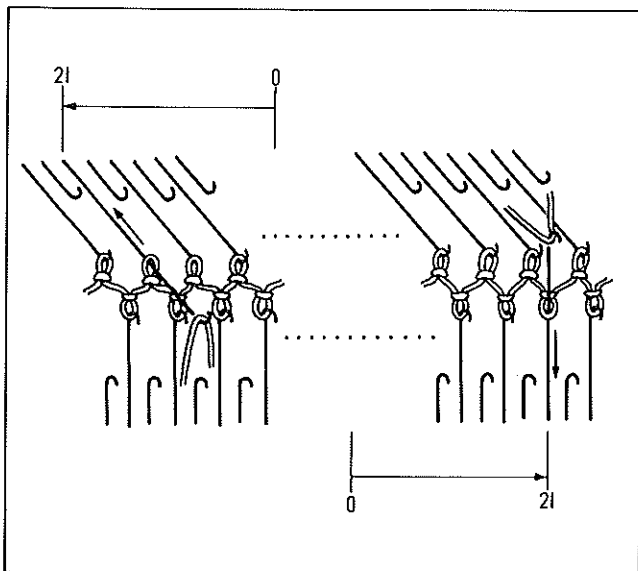

When the tension swatch is completed, remove it from the machine and leave it for several hours so that it can relax, then stretch the swatch widthways, until it looks how you want the finished garment to look.

Pin it flat and square.

Allow the swatch to dry, take a tension gauge over it as it is pinned down, following the instruction on page 5.

Hold a steam iron above the knitting, and blow steam evenly all over the swatch.

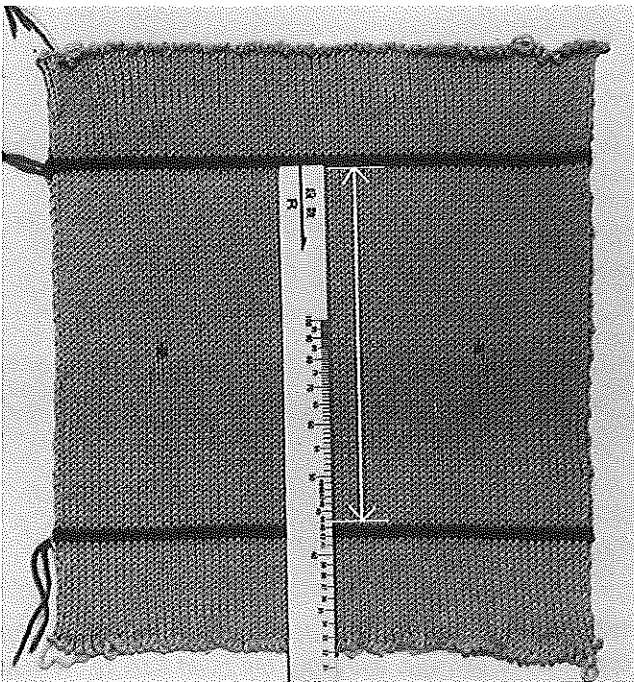
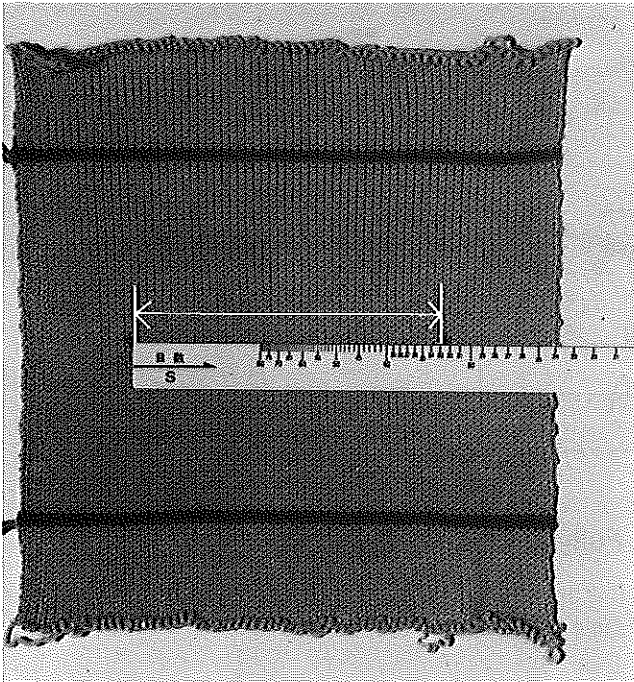
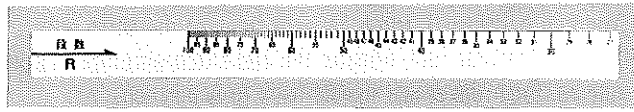
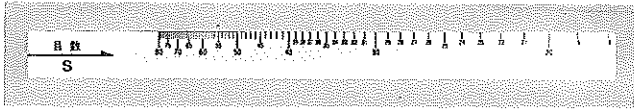

## Gauge Scale

This scale is designed to get how many stitches and rows per 10cm., measuring between yarn marks on the tension swatch.

The scale has two sides. The side "S" is used for measuring stitches and the side "R" is for rows.

Following the instructions below, measure and get correct tension gauge.

## How to measure the tension swatch

### Stitch (Horizontal)

Place the Gauge Scale (green) with the "S" side up, onto the tension swatch so as the left end of the scale is touching the inside of the stitch in a contrast yarn. Measure to the inside of the right contrast stitch. The number at this point indicates how many stitches are required to knit 10cms. The scale should be used from the edge indicated by the arrow, i.e. from the left edge.

### Row (Vertical)

Place the Gauge Scale (green) with the "R" side up, so as the arrow end of the Gauge Scale at the top of the tension swatch, is touching just below the rows knitted in contrast yarn. Measure to the inside of the two contrast rows at the bottom of the tension swatch. The number at this point indicates how many rows are required to knit 10cms. The scale should be used from the edge indicated by the arrow.

# KNITTING TECHNIQUES — on the knitter —

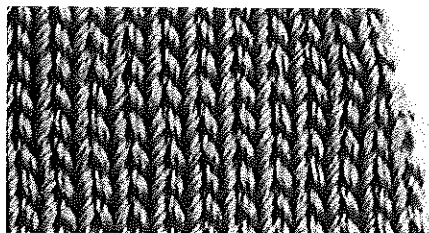

## Decreasing 1 stitch

You can decrease 1 stitch on both sides of the same row. Using a Transfer Tool, transfer the end stitch onto the adjacent needle. Push the empty needle back to A position.

*When Lace Carriage is in use, decrease the stitch at the edge opposite the Carriage, and move the Point Cam to the new position.*

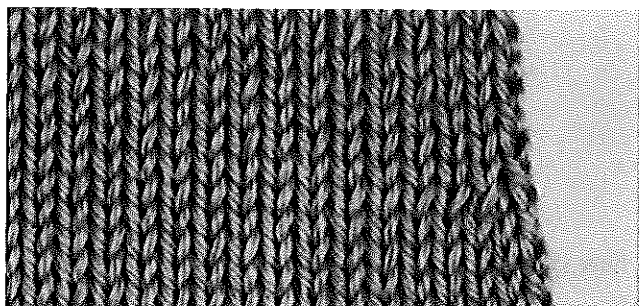
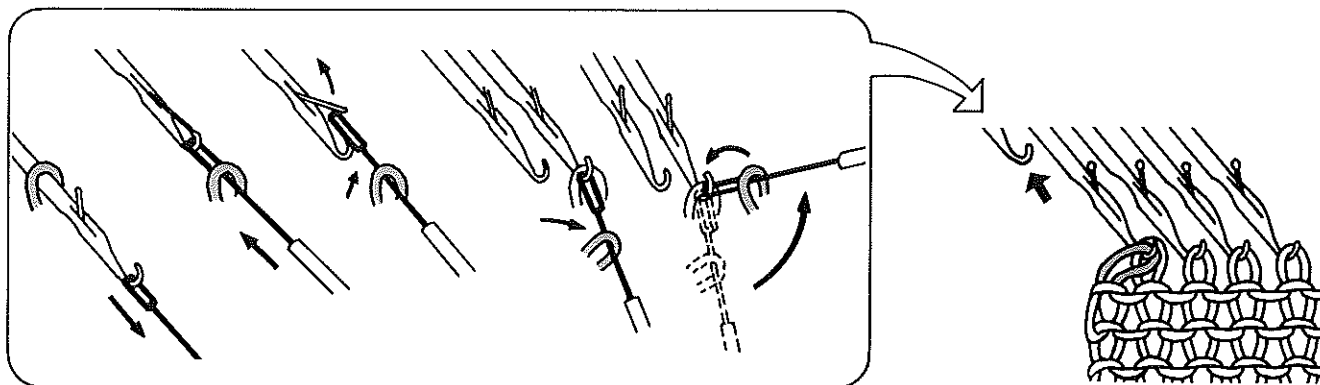

## Fully fashioned decrease

It is possible to decrease 1 stitch at both ends of the row at the same time.

1. Using a two prong Transfer Tool, transfer the two end stitches one needle in.

When using alternate needles, use a three prong Transfer Tool.

2. Push the empty needle back to A position. Continue to knit.

*When Lace Carriage is in use, decrease the stitch at the edge opposite the Carriage, and move the Point Cam to the new position.*

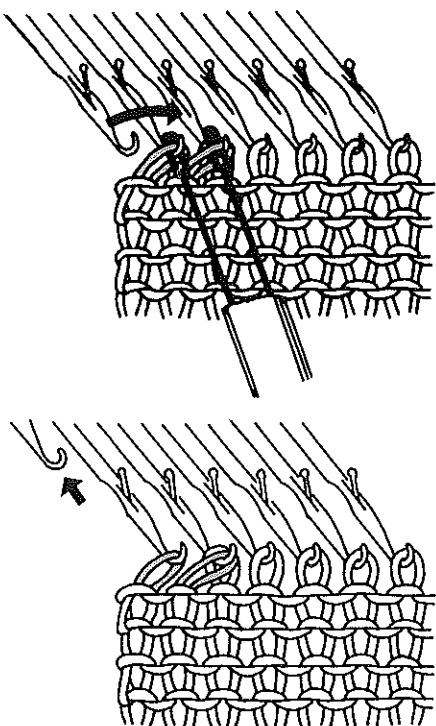



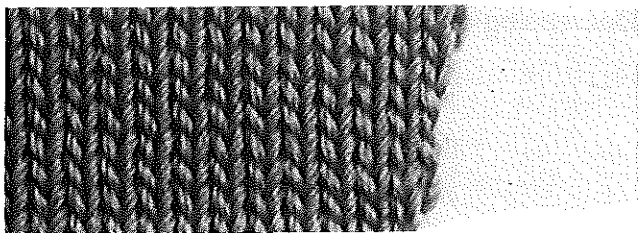

### Increasing 1 stitch

You can increase 1 stitch at a time only on the Carriage side of the knitting.

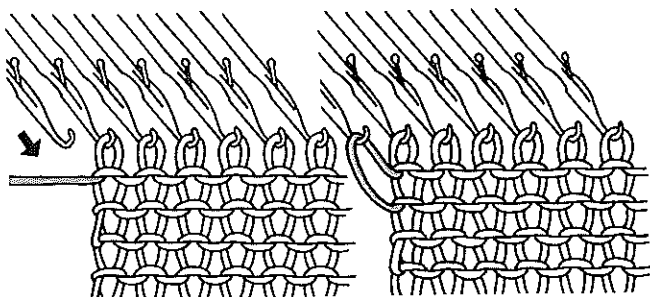

Push 1 needle at the Carriage side from A to B position and knit 1 row.

*When Lace Carriage is in use, move the Point Cam to the new position.*

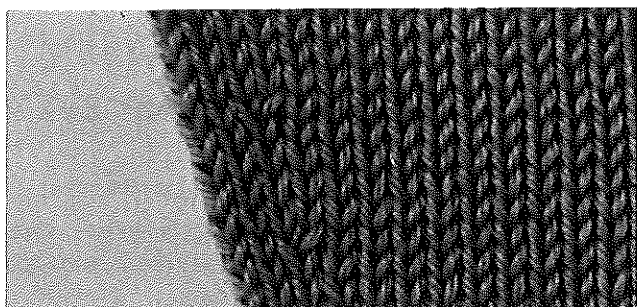

### Fully fashioned increase

It is possible to increase 1 stitch at both edges of the row at the same time.

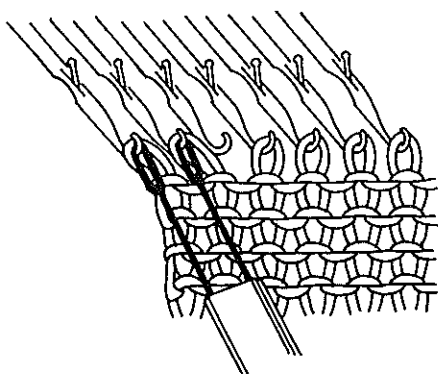

1. Push the adjacent empty needle to B position. Using a two prong Transfer Tool, transfer the two end stitches one needle out.  
When using alternate needles, use a three prong Transfer Tool.

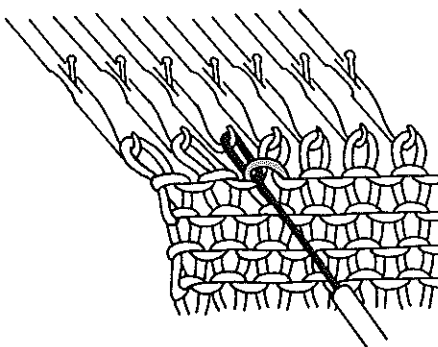

2. Pick up the loop below the third stitch and place it onto the empty needle as shown.  
Continue to knit.

*When Lace Carriage is in use, move the Point Cam to the new position.*

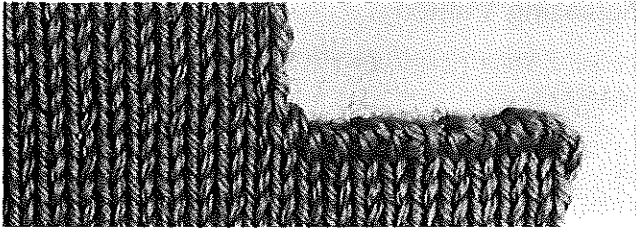

## Decreasing multiple stitches

You can decrease only on the Carriage side.

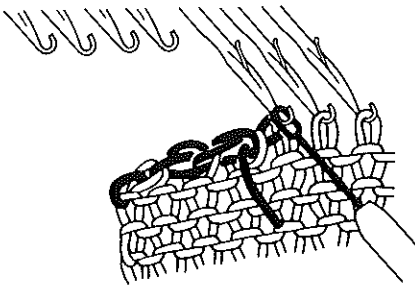
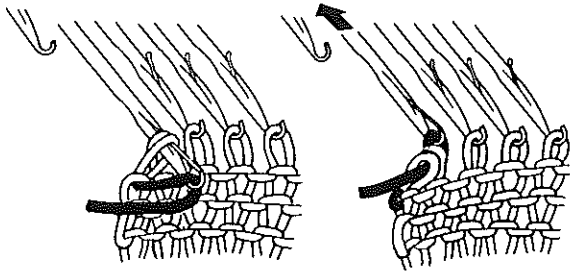
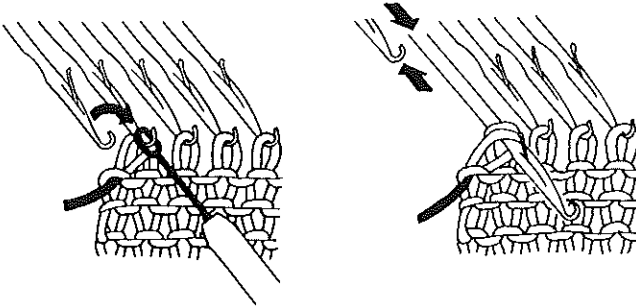

To decrease at the left edge:—

1. With the Carriage at the left, hold the knitting back towards the Knitter.  
Transfer the end stitch to adjacent needle. Push the empty needle back to A position.
2. Push the second needle to D position until both stitches are behind the latch.
3. Lay yarn from left to right in the open hook of the needle.  
(When decreasing at the right edge, lay yarn from right to left.)
4. Hold yarn slightly down and push the needle back to B position.  
The two stitches slip off the needle leaving a new stitch.
5. Continue the same procedure until the required number of stitches have been decreased.  
Place the last decreased stitch onto its adjacent needle.

*When Lace Carriage is in use, using a length of main yarn, decrease the stitches at the edge opposite the Carriage and move the Point Cam to the new position.*

\* Repeat in reverse to decrease at the right.

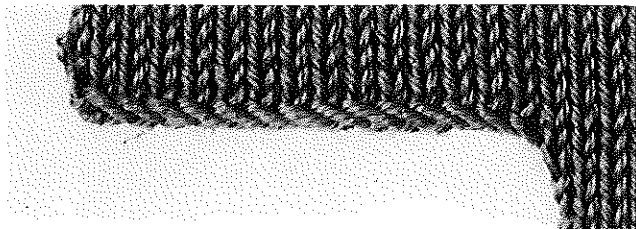

## Increasing multiple stitches using Main Carriage

You can increase only on the Carriage side.

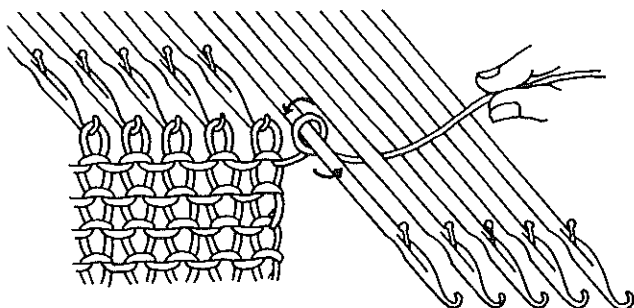

When the Carriage is on the right side:—

1. Push the required number of needles from A to D position. Pull some yarn from the Yarn Feeder and wind it loosely around the empty needles in the anti-clockwise direction.
2. Push loops against sinker posts, eliminate slack yarn, and continue knitting with the Russel Levers at II.

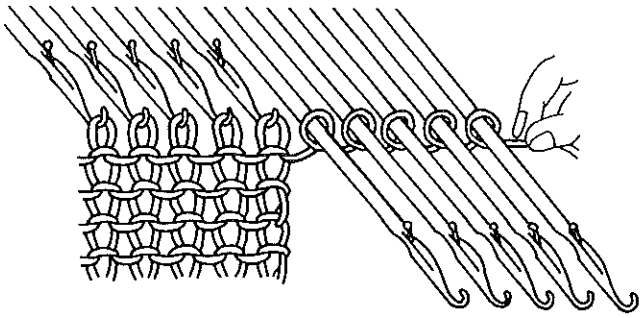

When the Carriage is on the left side, wind yarn around needles in the clockwise direction.

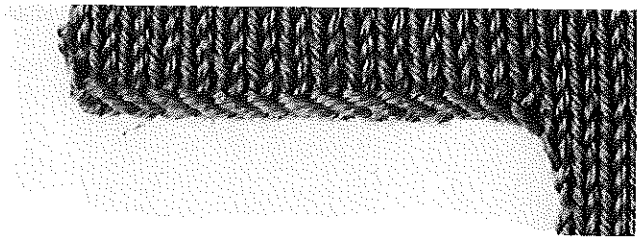
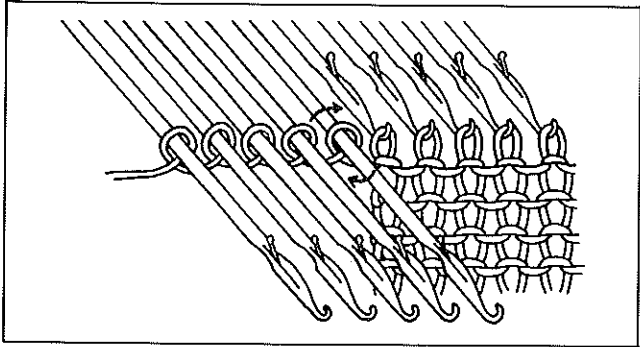

### Increasing multiple stitches using the Lace Carriage

You can increase only on the Carriage side.

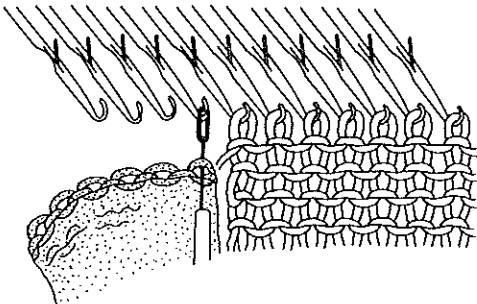

1. Push the required number of needles for increase from A to B position.  
Take a piece of waste knitting, and using the Transfer Tool, pick up stitches from it and hook them on the needles.

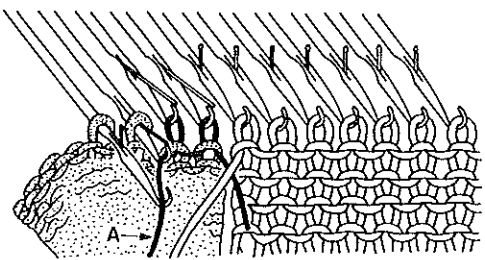

2. Push the needles from B to D position and lay the Ravel Cord "A" inside needle hooks.  
(Stitches of the knitted piece are behind needle latches.)  
Push the needles one by one back to B position to form loops.

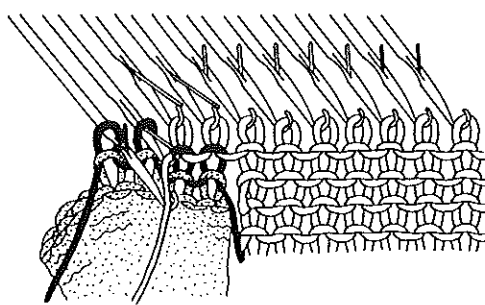

3. Push the needles from B to D position and lay the main yarn inside the needle hooks.  
Push the needles one by one to form loops in the same manner as done for the Ravel Cord.  
Knit 1 row.  
*Move the Point Cam to the new position.*  
Knit the required number of rows.

4. Before removing Ravel Cord, back stitch through stitches immediately above Ravel Cord.

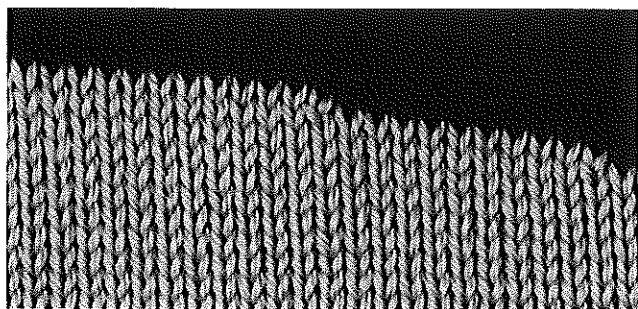

**PARTIAL KNITTING** is used to shape a gentle slope, such as shoulders, darts, etc.

You can do partial knitting only on the opposite side to the Carriage. If you wish to shape both sides, work left and right alternately.

### Decreasing stitches using the Main Carriage

Set the Russel Levers to **I**.

1. Push the needles to be decreased to D position on the opposite side to the Carriage.

2. Knit 1 row.  
The needles in B position knit. The needles in D position remain inactive and the yarn passes over them.

3. To prevent a hole from being formed in the knitting, pass the yarn under the first inside needle in D position and over the remaining needles. (If partial knitting is required on both sides, repeat step 1 before knitting the next row.)

4. Knit 1 row.  
This completes the first operation of partial knitting. (If partial knitting is required on both sides, apply step 3.)

Repeat steps 1 ~ 4.

After completing partial knitting, continue as follows.

#### A. Stockinet

Push the needles in D position on the opposite side to the Carriage back to C position. Knit 1 row. Needles in C position will knit and return to B position. Repeat this step if partial knitting has been worked on both sides.

#### B. Pattern knitting

Using a Transfer Tool, push the needles in D position back to B position on the opposite side to the Carriage, until the stitches move onto the Transfer Tool, then place the stitches in the needle hooks.

Knit 1 row.

Repeat this step if partial knitting has been worked on both sides.

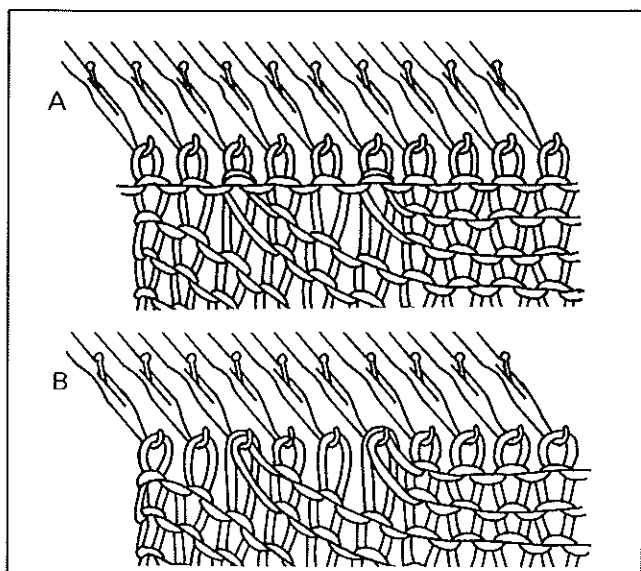
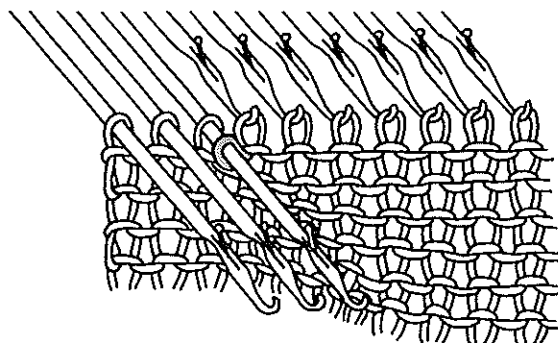
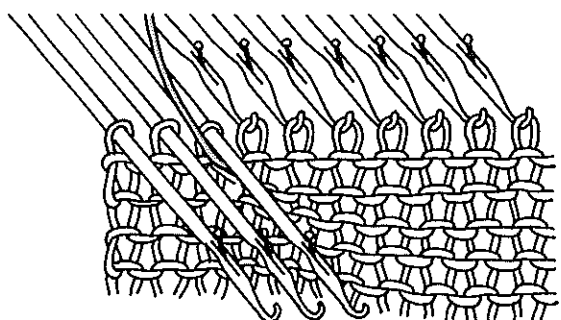
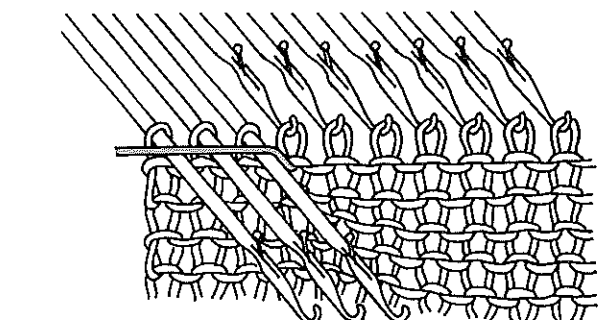

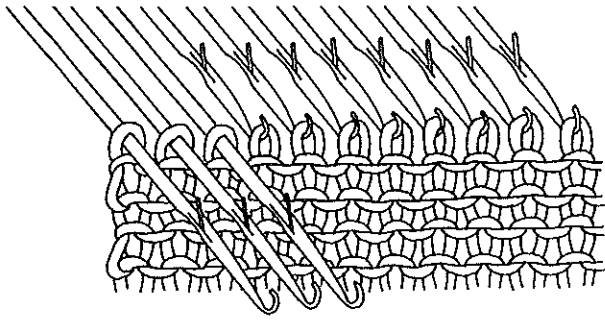

## Decreasing stitches using the Lace Carriage

1. Push the needles to be decreased to D position on the opposite side to the Carriage.

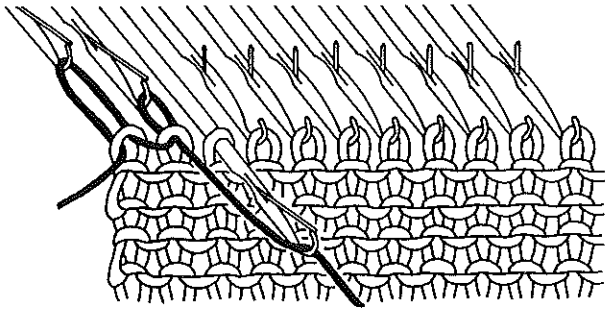

2. Lay the Ravel Cord into the open needle hooks, and knit the needles back one by one from D to A position by hand.

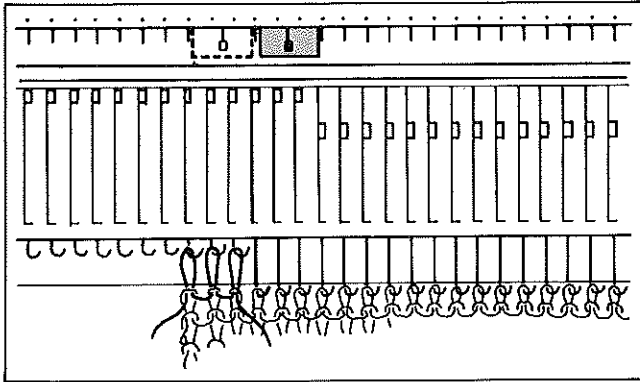

3. Replace the Point Cam over the two end needles in B position.

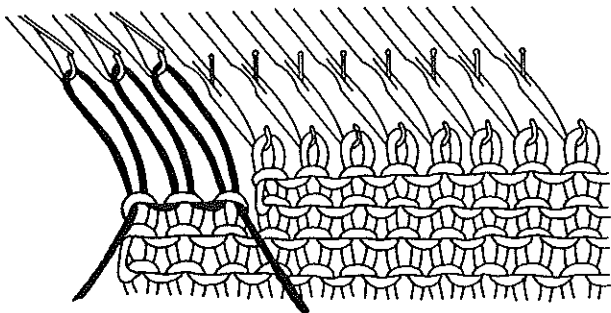

4. Knit 2 rows. (If partial knitting is required on both sides, knit 1 row only, then repeat steps 1 ~ 3. Knit 1 row.)

5. Repeat steps 1 ~ 4.

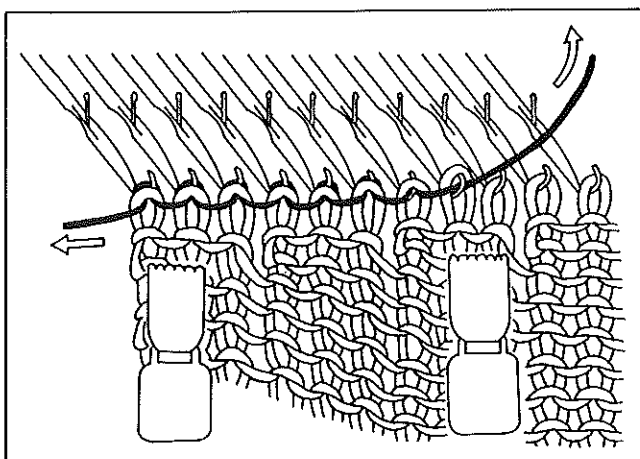

*After completing the partial knitting, hang the Claw Weights and replace the stitches in the needle hooks by pulling out the Ravel Cord on the opposite side to the Carriage. Replace Point Cam over two end needles. If partial knitting has been worked on both sides, knit 1 row, then repeat this section on the other side.*

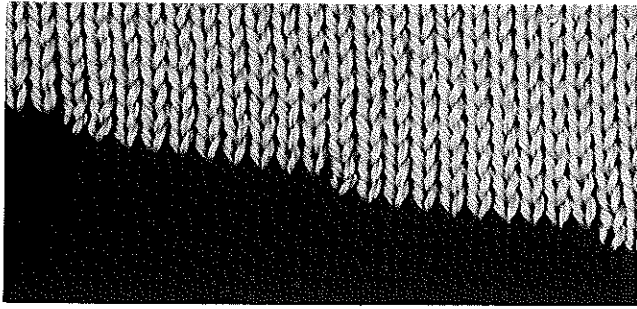

## Increasing stitches using the Main Carriage

Set the Russel Levers to **I**.

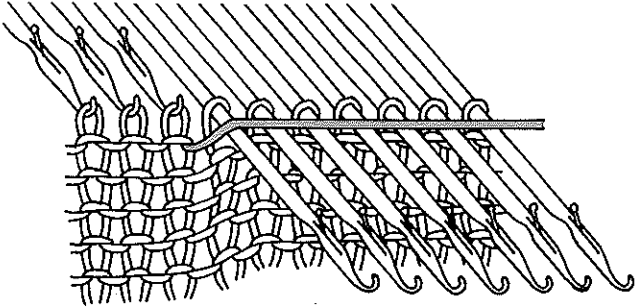

1. Push the required number of needles opposite the Carriage to **D** position.

2. Knit 1 row.  
(The needles in **B** position knit the yarn. The needles in **D** position remain inactive and the yarn passes over them.)

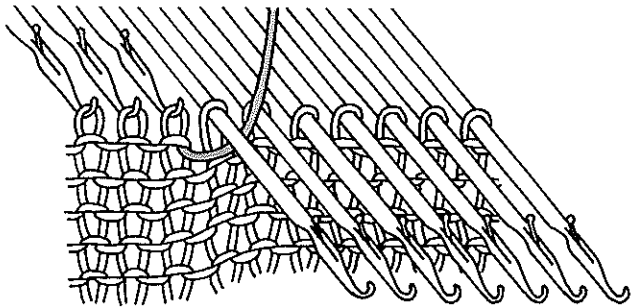

3. To prevent a hole forming, pass the yarn under the first inside needle in **D** position and over the remaining needles. (If partial knitting is required on both sides, repeat step 1 before knitting next row.)

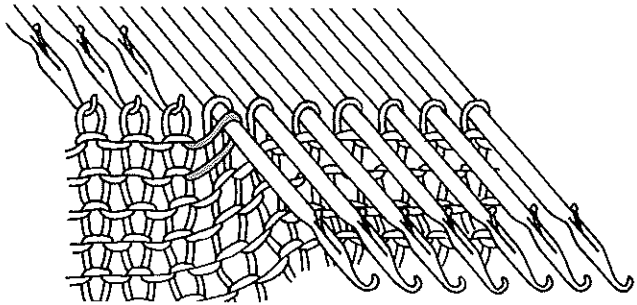

4. Knit 1 row.

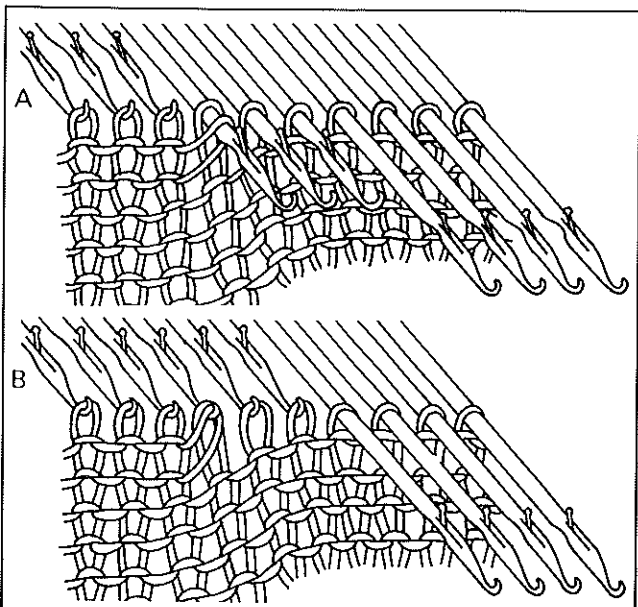

5. Before knitting the next row, work on the side opposite the Carriage as follows.

### A. Stockinet knitting

Push the needles to be increased back to **C** position.

### B. Pattern knitting

Using a Transfer Tool, return the needles to be increased back to **B** position.

Align the needles correctly in **B** position.

6. Repeat steps 2 ~ 5, but if partial knitting has been worked on both sides, repeat steps 2, 3 and 5 only.

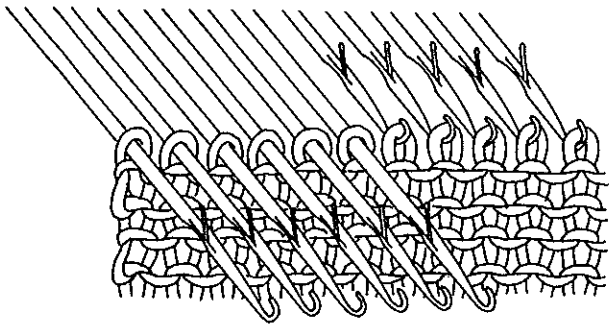

### Increasing stitches using the Lace Carriage

1. Push the required number of needles opposite the Carriage to D position.

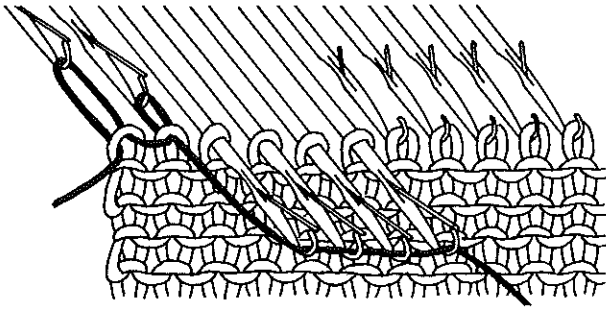

2. Lay the Ravel Cord into the open needle hooks and knit the needles back one by one from D to A position.

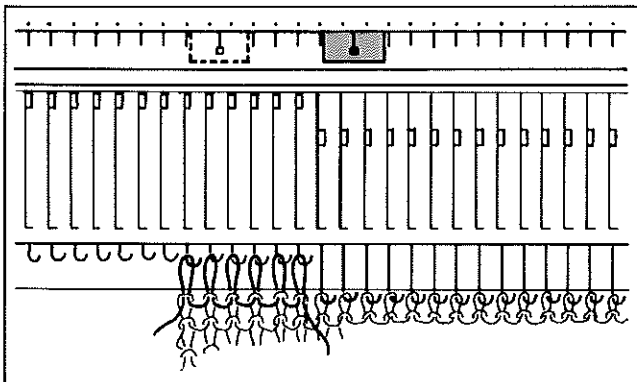

3. Replace the Point Cam over the end two needles in B position.

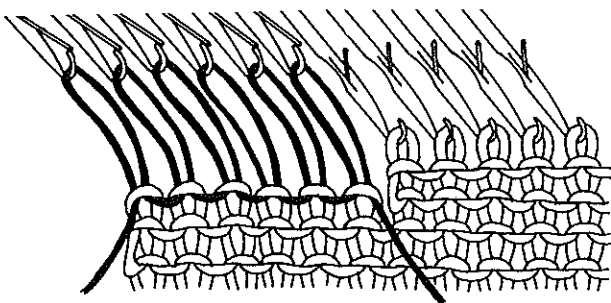

4. Knit 2 rows.  
(If partial knitting is required on both sides, knit 1 row only, then repeat steps 1 ~ 3. Knit 1 row.)

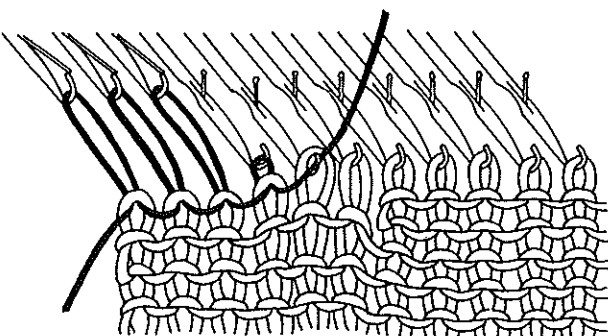

5. On the side opposite the Carriage, unravel the required number of stitches to be increased by pulling the Ravel Cord to the side with the Carriage and replace the stitches in main yarn into their needle hooks.

6. Replace the Point Cam over the end two needles in B position.

7. Knit 2 rows. (If partial knitting is required on both sides, knit 1 row only.)

Repeat steps 5 ~ 7.

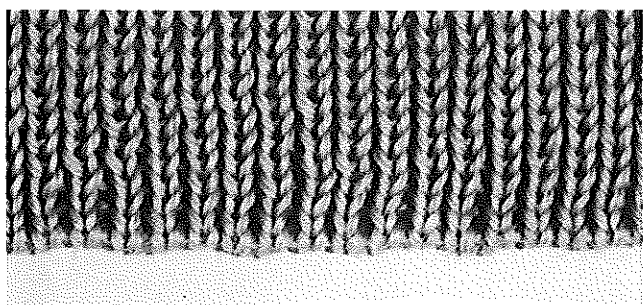

## K1.P1. Rib

If you don't have a Ribber, this method of knitting Rib can be used for knitting cuffs, neckbands and welts.

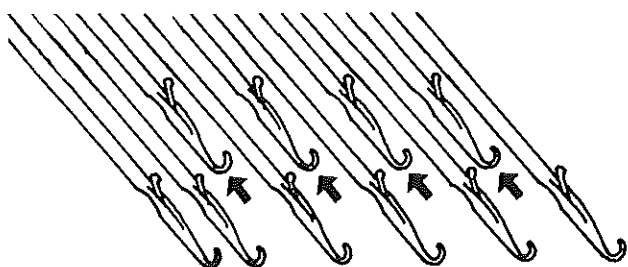

1. Push the required number of needles to B position. Push back every alternate needle to A position, starting with the third needle from the left side.

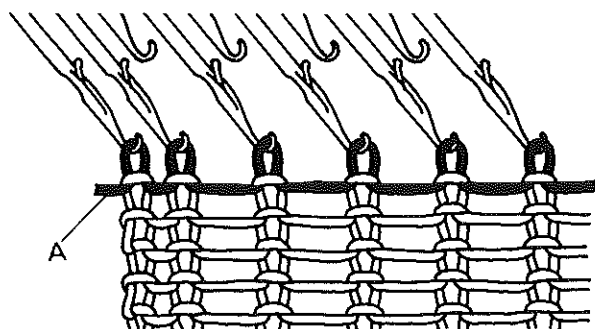

2. Cast-on and knit several rows with waste yarn. Hang Claw Weights at both edges of knitting. Knit 1 row with Ravel Cord "A"

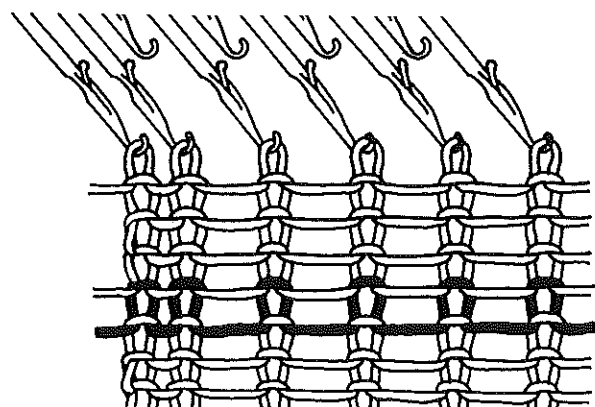

3. Thread the main yarn and knit 4 rows with the Stitch Dial at 0.

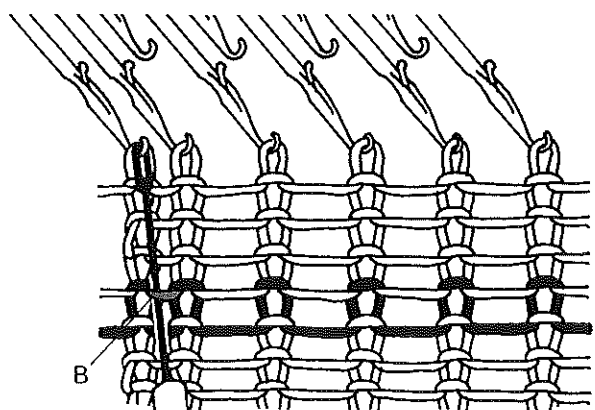

4. Insert the Transfer Tool into the left end sinker loop "B" on the first row of the main knitting. (Above the Ravel Cord)



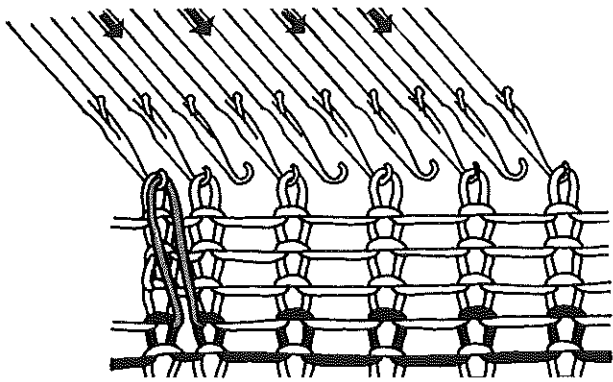

5. Place the loop onto the end needle. Push the needles that were in A position in step 1, to B position.

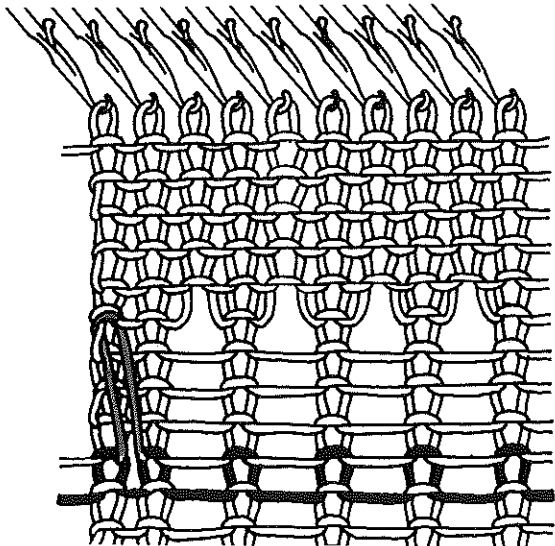

6. Knit the length required for ribbing with the Stitch Dial 2 numbers lower than for Stockinet.

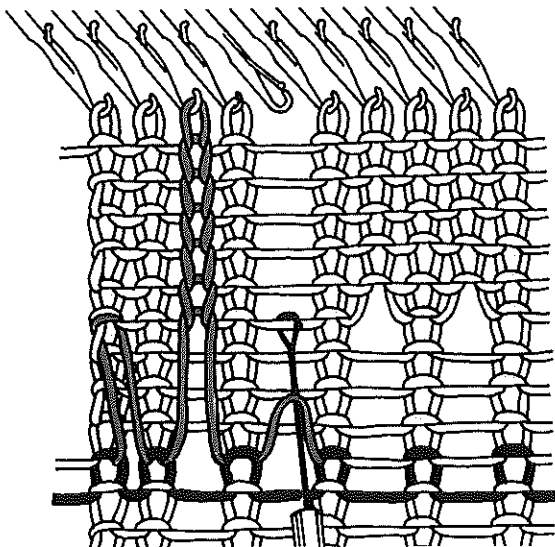

7. Insert the Tappet Tool into the loop of the first row of main knitting and unravel the stitches as shown. Skip over the next 3 rows and catch the yarn on the 5th row crossing above, in the hook of the Tappet Tool.

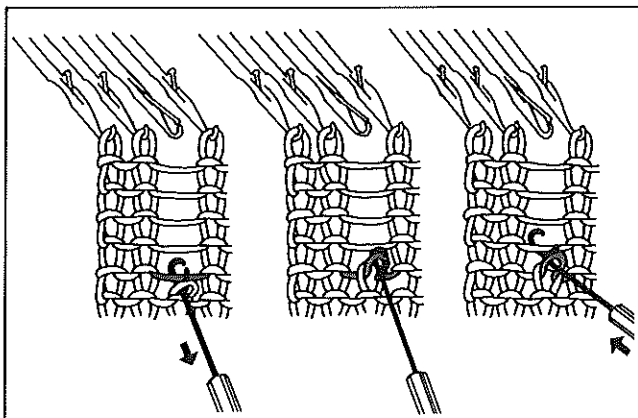

8. Pull the Tappet Tool towards you. The first stitch will slip off the Tappet Tool, forming a new stitch.

9. Catch the yarn on the next row crossing above and pull the Tappet Tool towards you.

10. Repeat step 9 for every row. Place the last stitch back onto its needle.

Reform every alternate stitch as above.

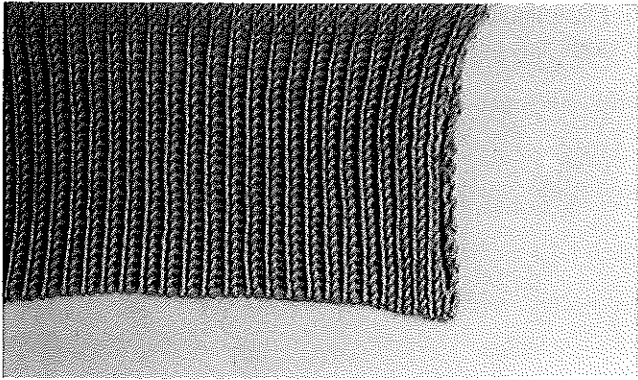

## Mock Rib

Mock Rib can be used instead of K1.P1. Rib.

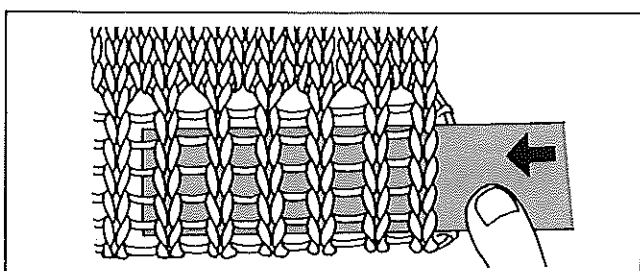
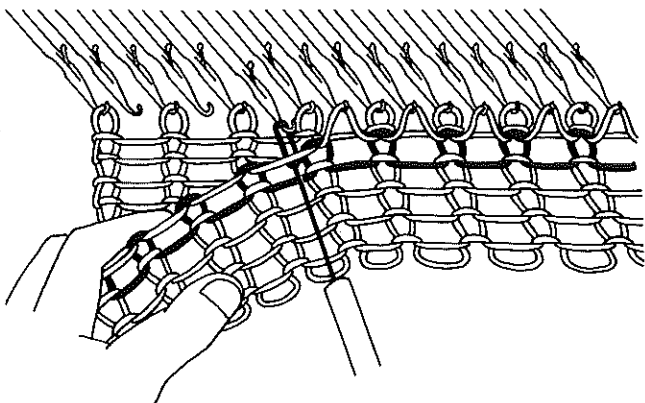
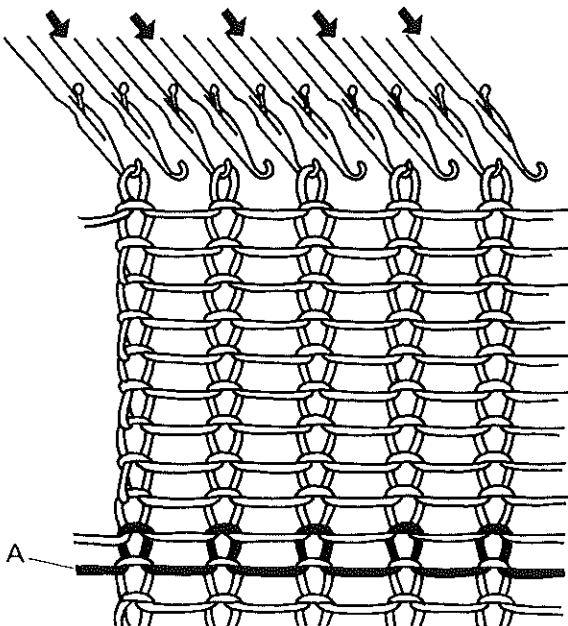
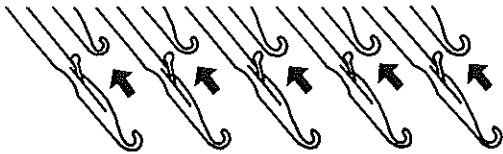

1. Push the required number of needles to B position and push back every alternate needle to A position starting with the second needle from the left side.

2. Cast-on and knit several rows with waste yarn. Knit 1 row with Ravel Cord "A".

3. Thread the main yarn and set the Stitch Dial 3 ~ 4 numbers lower than for Stockinet, and knit twice the number of rows required for Mock Rib.

4. Push the needles that were in A position in step 1, to B position.

5. Using Transfer Tool, pick up the sinker loops on the first row of the main knitting above the Ravel Cord and place them onto the empty needles in B position.

6. Re-set the Stitch Dial to the number used for Stockinet knitting and continue to knit. Pull out the Ravel Cord to remove the waste knitting.

When pressing, insert a ruler into the side opening of Mock Rib and pull the knitting vertically, to close up the stitches.

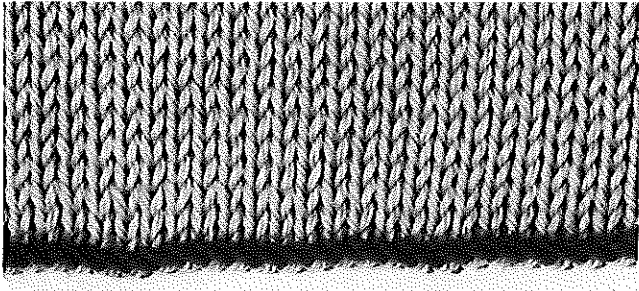

## Cast-on by winding yarn

1. Cast-on with waste yarn and knit several rows ending with the Carriage at the left. Then knit 1 row with the Ravel Cord.

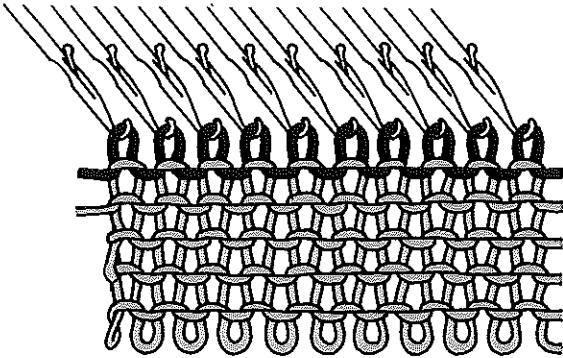

2. Push the needles to D position.

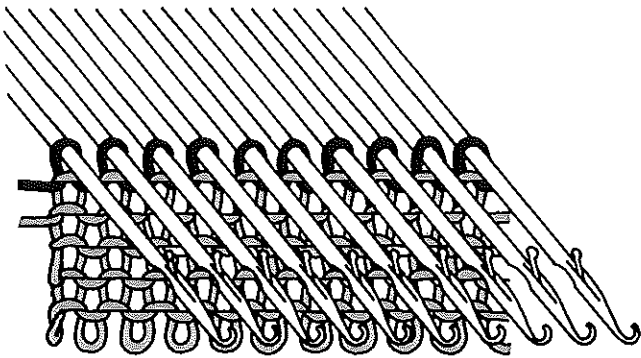

3. Wind the main yarn around the needles in an anticlockwise direction, starting from the left.

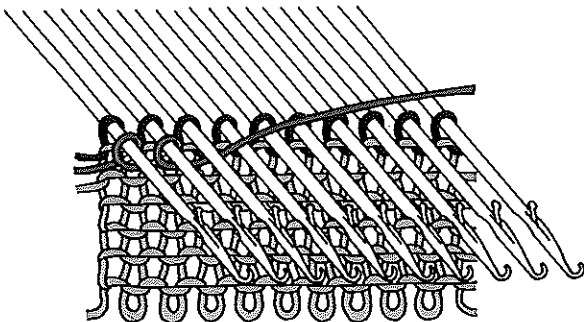

4. Thread the main yarn through the Yarn Feeder.
5. Set both Russel Levers to II, and continue to knit.

\* After knitting 6 ~ 7 rows with the main yarn, pull out the Ravel Cord to remove the waste knitting. The cast-on row is closed.

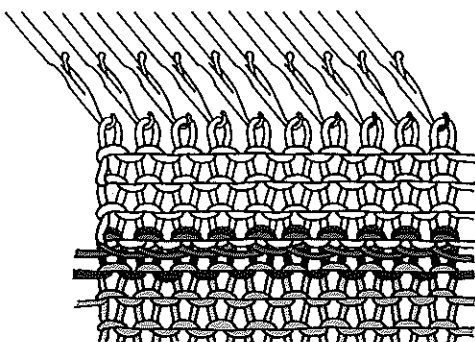

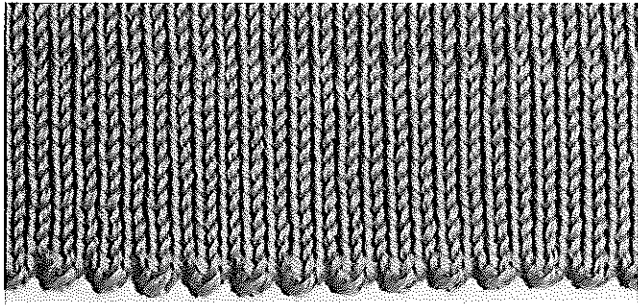

## Picot Hem

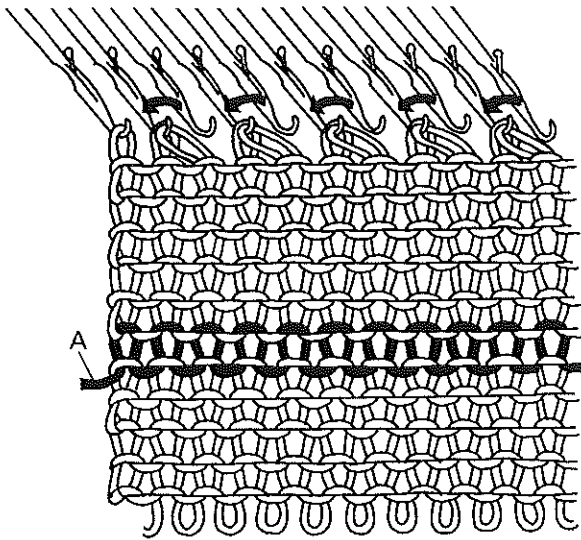

1. Arrange an even number of needles in B position. Cast-on and knit several rows with waste yarn. Knit 1 row with the Ravel Cord "A". Set the Stitch Dial 1 number lower than for Stockinet and knit with the main yarn, 1 row less than required for the length of the hem.

2. Make picot eyelets by transferring every alternate stitch to its adjacent needle. Leave the empty needles in B position.

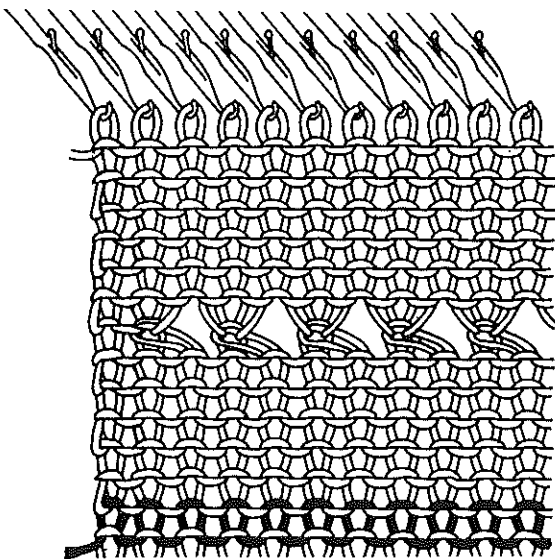

3. Reset the Stitch Dial to the original setting for Stockinet knitting, and knit the required number of rows for the length of the hem.

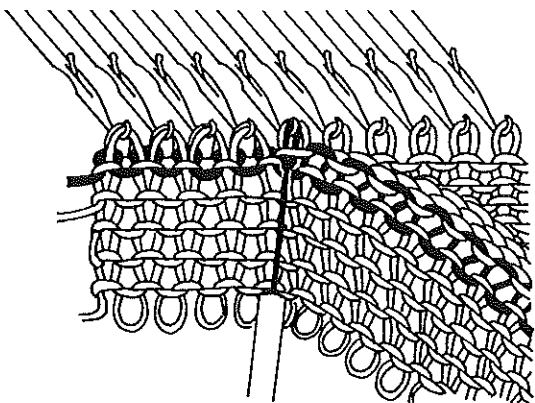

4. Place the sinker loops of the first row of the main knitting onto their corresponding needles. Remember to pick up the edge sinker loop.
5. Set the Stitch Dial 2 numbers higher than the number originally used and knit 1 row. Pull out the Ravel Cord to remove waste knitting. Reset the Stitch Dial to the original setting for Stockinet knitting and continue to knit.

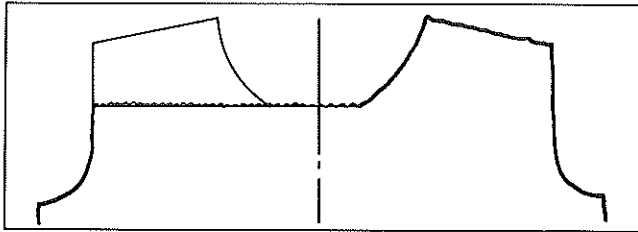

## Holding stitches

If it is necessary to shape a garment in sections, use one of the following methods.

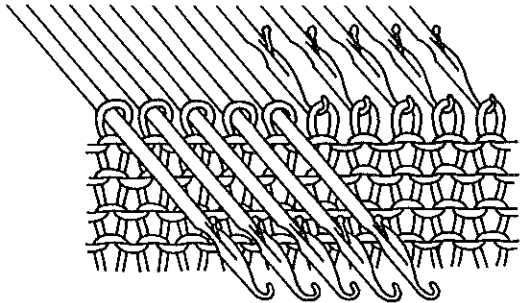

### In D position (Main Carriage only)

1. Push the needles for the section to be held to D position.

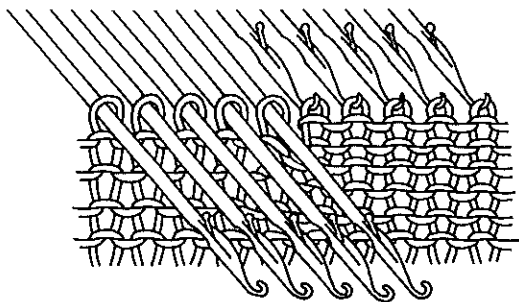

2. Set the Russel Levers to **I**, and continue to knit.

To continue knitting on the stitches which have been held, push the needles back to C position, and continue to knit. (Stockinet only)

### When pattern knitting

Return the needles which have been held to B position using a Transfer Tool. Replace the stitches in the needle hooks.

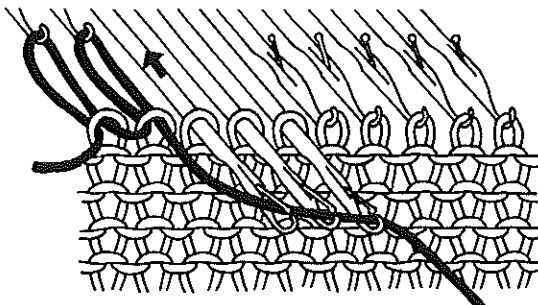

### Using Ravel Cord

1. Push the needles for the section to be held to D position, and lay the Ravel Cord inside the hooks.
2. Starting from the end needle, push the needles back to A position manually.

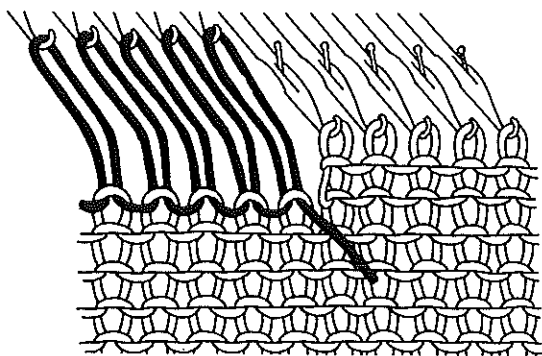

3. Continue to knit.  
Before starting each row, make sure that the needles are well back in A position.

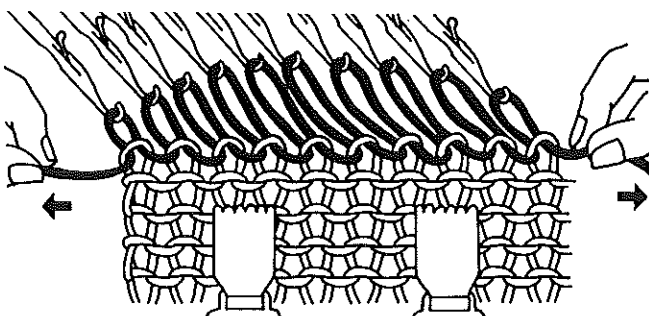

To return the needles to B position, hang Claw Weights on the knitting and replace the stitches in needle hooks by pulling the Ravel Cord.

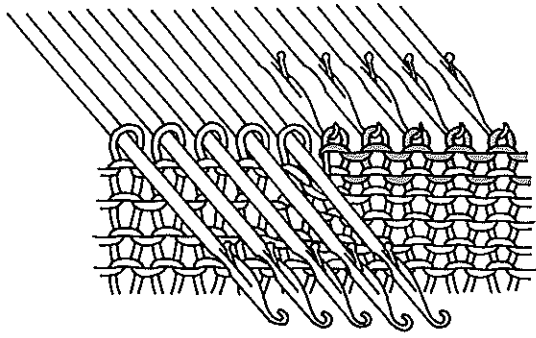

### Waste yarn I (Main Carriage only)

Set the Cam Lever to Stockinet and the Russel Levers to **I**.

1. Leave the needles for the stitches to be removed with waste yarn in B position. Push the remaining needles to D position.
2. Thread waste yarn into the Yarn Feeder and knit several rows. Remove this section from the machine.

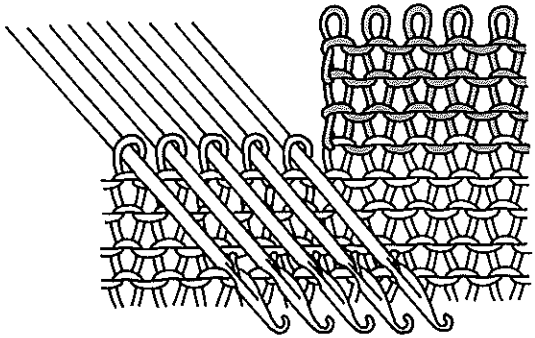

3. Push needles from D position back to C position for Stockinet, or return to B position with a Transfer Tool for pattern knitting (refer to page 12). Reset the Carriage to the original settings and continue to knit.

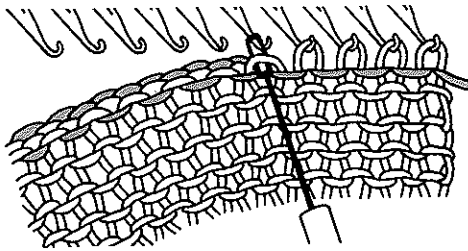

*To continue knitting the stitches held on waste knitting, pick up the stitches on the last row of the main knitting and place them onto the corresponding needles.*

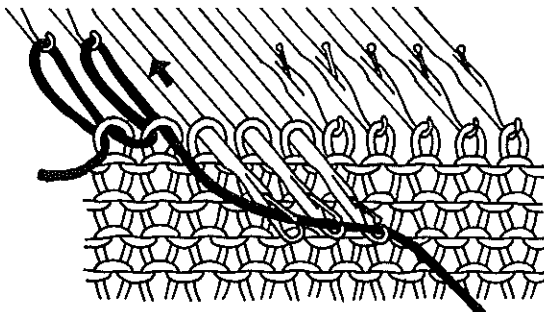

### Waste Yarn II (for Lace Carriage)

1. Push the needles to be held to D position.
2. Starting with the end needle, lay the Ravel Cord in the needle hooks and push the needles back to A position.

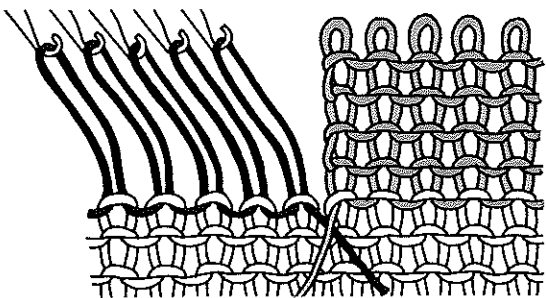

3. Press "ON" the Inspection Switch, set the Cam Lever to Stockinet, and knit several rows with waste yarn on the needles in B position. Remove this section from the machine.

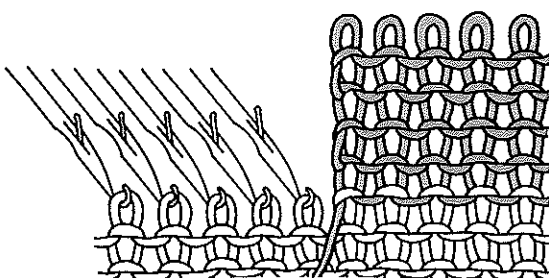

To continue knitting the held stitches, press "OFF" the Inspection Switch, set the Cam Lever for Lace.

Check that the arrow on the Pattern Card points in the same direction as the Carriage, and unravel the Ravel Cord to replace the stitches in the needle hooks. (refer to page 19.)

*To continue knitting the stitches held on waste knitting, pick up the stitches on the last row of the main knitting and replace them onto the empty needles.*

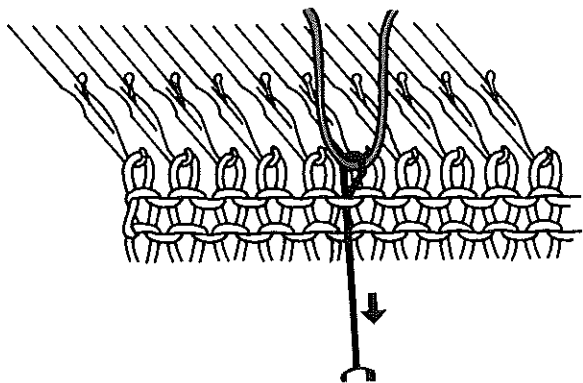

### To put yarn mark

Insert the Tappet Tool into the sinker loop to be marked.  
Take a length of waste yarn and make a loop on the Tappet Tool.  
Pull the Tappet Tool through the sinker loop.

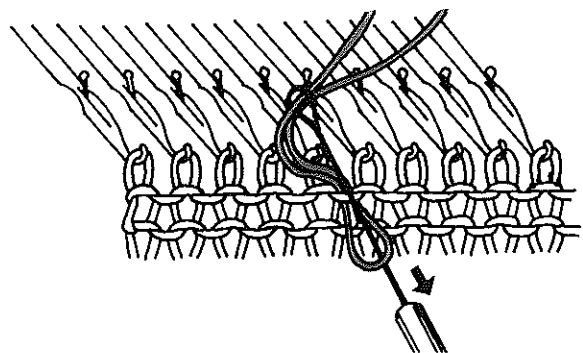

Catch both ends of the waste yarn and pull out the Tappet Tool through the loop.

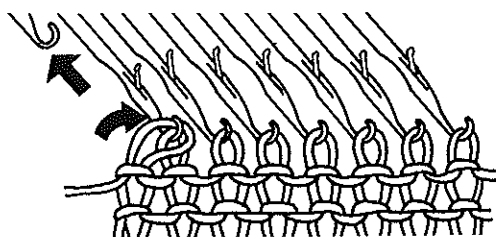
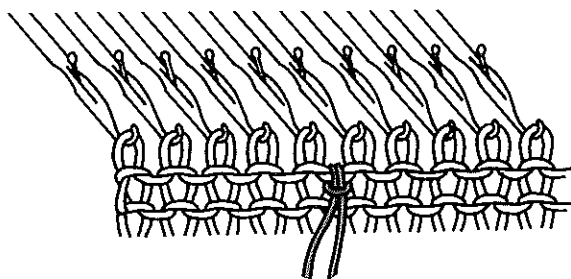

### To cast off with Transfer Tool

Knit last row and break the yarn leaving the end 3 times the width of the knitting.

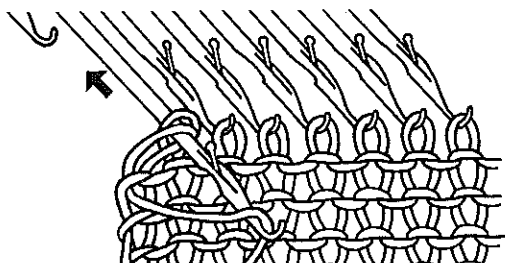

1. Transfer the first stitch to the second needle and push the empty needle back to A position.

2. Push the second needle to D position so both stitches are behind the latch and lay the yarn in the needle hook.

3. Push the needle back to B position.

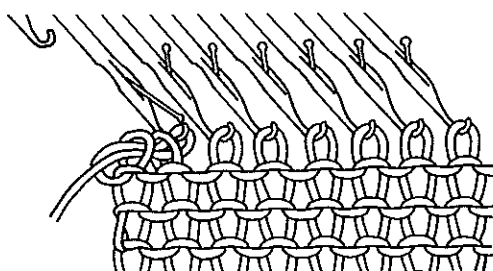

4. Repeat steps 1 ~ 3.

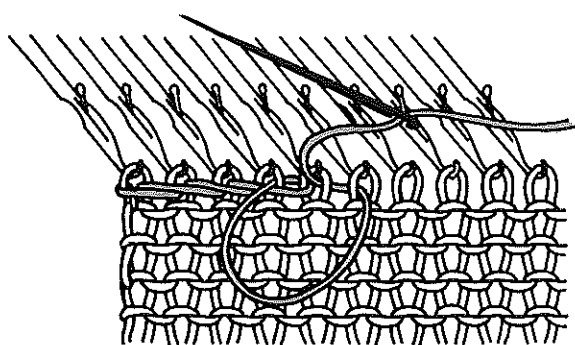
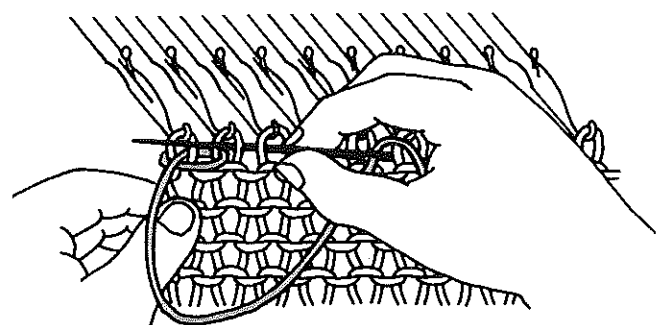
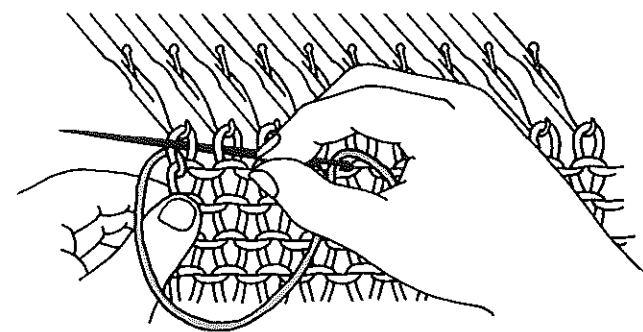
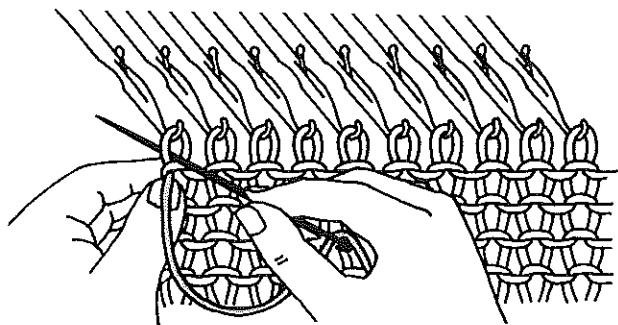

## To cast off using Back Stitch method

### A. In case of starting from the left end

Finish with the Carriage at the left. Break the yarn leaving a length of yarn about three times the width of the knitting.

1. Thread the Tapestry Needle. Insert it into the first stitch and pull the yarn through.
2. Insert the Tapestry Needle through the second stitch and pull out from the first stitch.
3. Insert the Tapestry Needle through the third stitch and pull out from the second stitch.
4. Repeat steps 2 ~ 3.  
Close the last stitch by inserting the yarn and guiding it out the stitch.



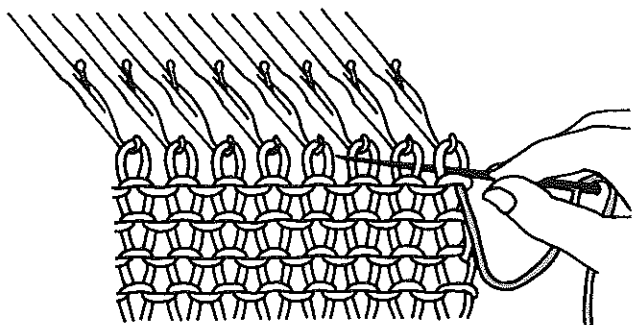

### B. In case of starting from the right end

Finish with the Carriage at the right. Break the yarn leaving a length of yarn about three times the width of the knitting.

1. Thread the Tapestry Needle. Insert it into the first stitch and pull out from the second stitch.

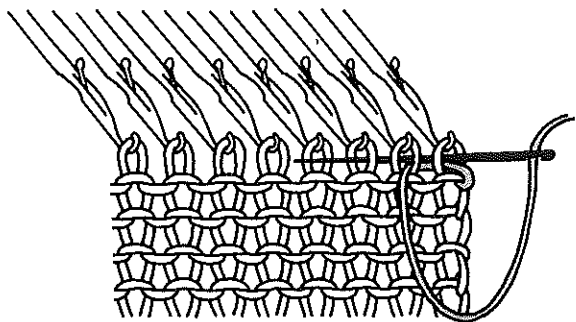

2. Insert the Tapestry Needle into the first stitch and pull out from the third stitch omitting the second stitch.

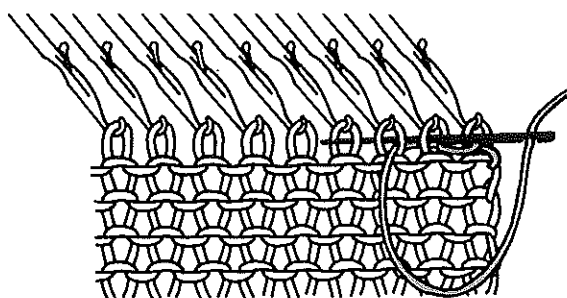

3. Insert the Tapestry Needle into the second stitch and pull out from the fourth stitch omitting the third stitch.

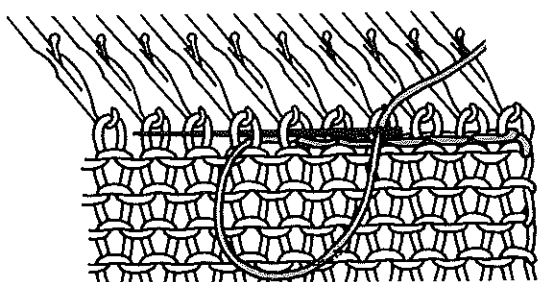

4. Continue to close all stitches.

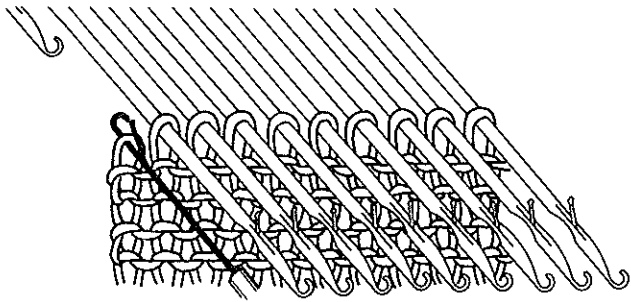

### To cast off with Tappet Tool

This is used to make a closed edge when knitting is completed.

1. Knit the cast off row with the Main Carriage, setting the Stitch Dial 3 ~ 4 numbers higher than the main tension. Push the needles to D position. On the side opposite the Carriage, catch the first stitch with the Tappet Tool and push the needle back to A position. The stitch is transferred onto the Tappet Tool.

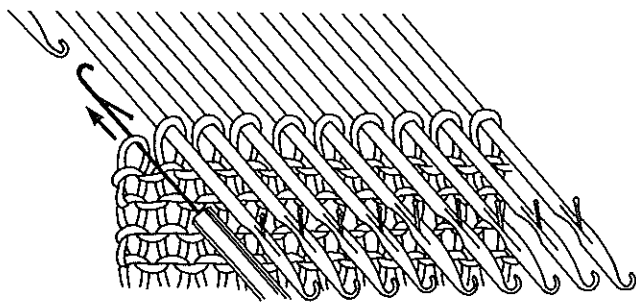

2. Push the stitch behind the latch of the Tool.

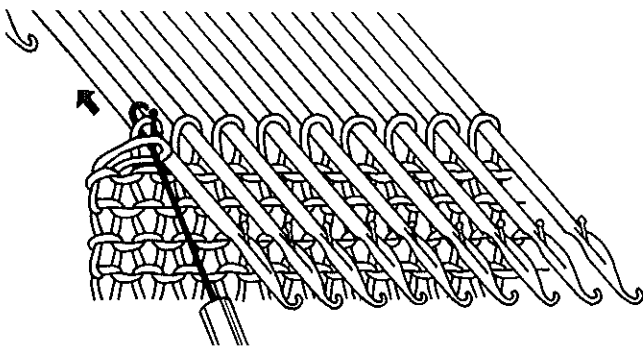

3. Catch the second stitch. Push the needle back as indicated by the arrow but pull the Tappet Tool in the opposite direction.

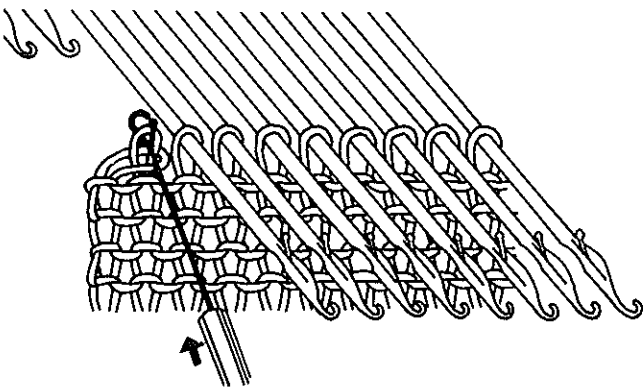

The first stitch will slip off the tool, leaving the second stitch in the hook of the Tappet Tool.

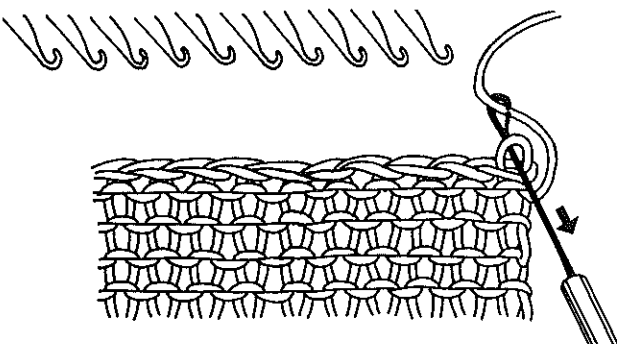

4. Repeat steps 2 ~ 3.  
Cast off the last stitch by pulling the yarn end through the stitch with the Tappet Tool as shown.

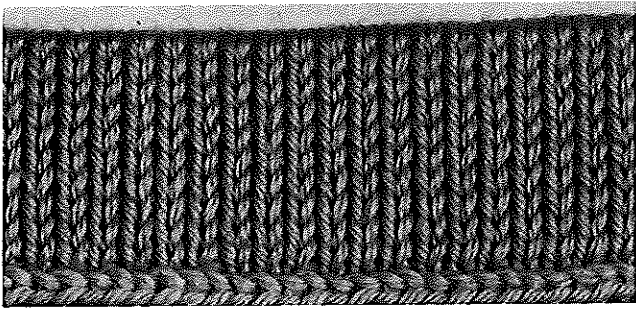

## Trimming

Used to trim neckbands, borders, etc.

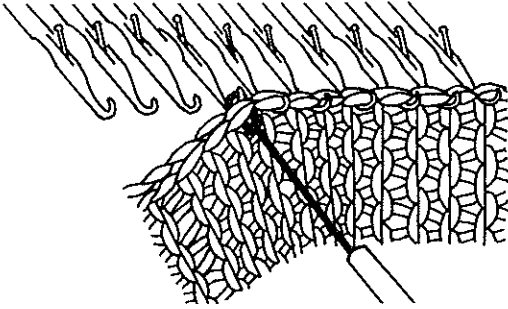

1. With the wrong side of the knitting facing you, pick up the edge stitches, and place onto the needles, omitting a stitch at appropriate intervals.

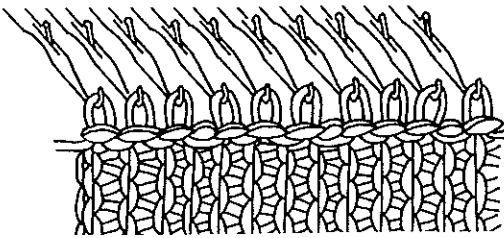

2. With the main yarn, knit 1 row in Stockinet with the Stitch Dial 1 number lower than that used for Stockinet.

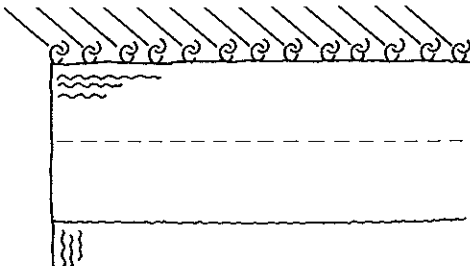

3. Reset the Stitch Dial to the original number and knit twice the number of rows required for the finished trimming.

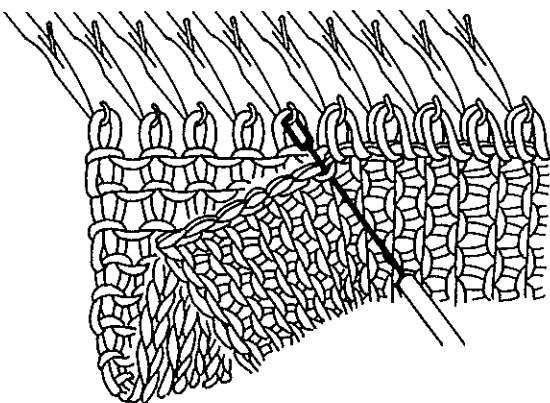

4. Pick up the sinker loops on the first row and place them onto the corresponding needles.

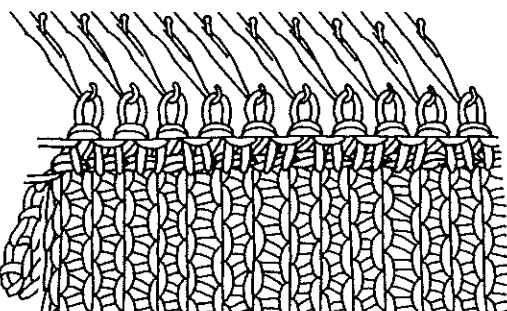

5. With the Stitch Dial set 2 numbers higher than Stockinet setting, knit 1 row.
6. Cast off with Transfer Tool.

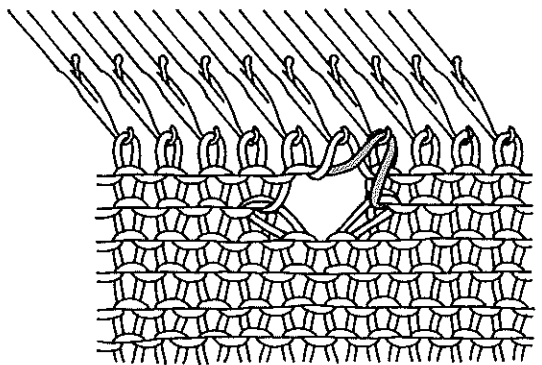
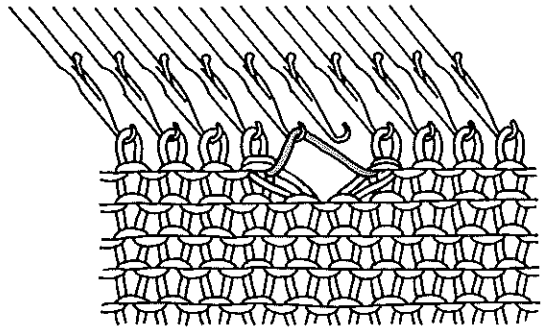
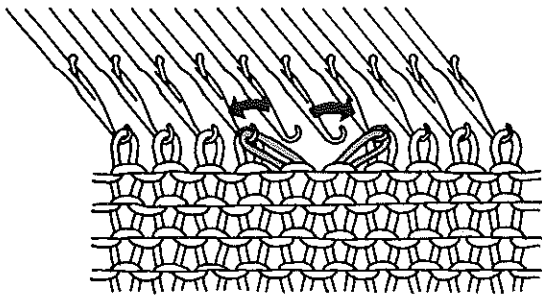

## Buttonhole by transferring stitches

### Double stitch eyelet

1. Transfer 2 stitches onto their adjacent needles respectively, as shown. Leave the empty needles in B position. Knit 1 row.
2. Remove the new loop from the right hand needle. Knit 1 row.
3. Pick up the yarn crossing above buttonhole and place it onto the needle as shown. Continue to knit up to the next buttonhole.

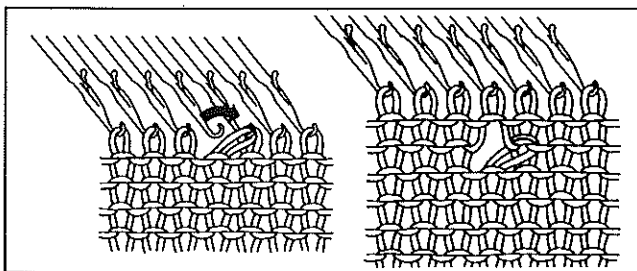

### Single stitch eyelet

Place 1 stitch onto its adjacent needle. Leave the empty needle in B position. Continue to knit.

When making buttonholes on a double border, adjust the number of rows or stitches between the inside buttonholes and outside buttonholes so that they match when the border is folded.

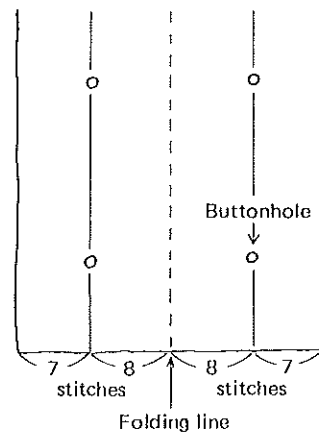
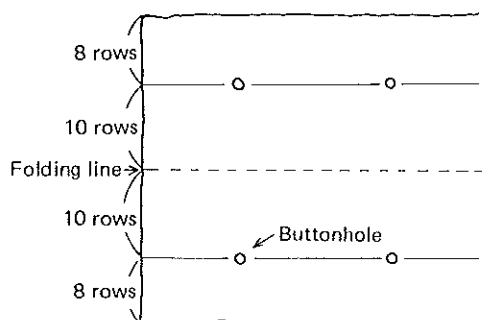

## K1.P1. Rib

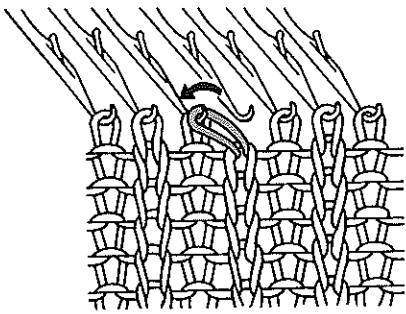

1. Reform the stitch for K1.P1. Rib and place the reformed stitch onto its adjacent needle.

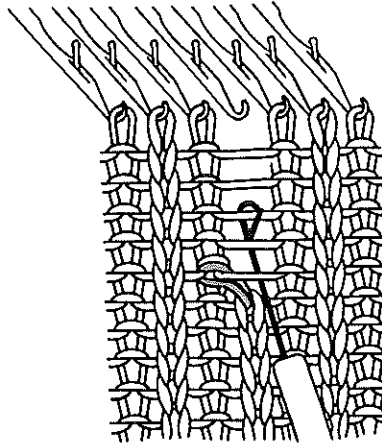

2. With the empty needle in B position, continue to knit. Unravel the row and insert the Tap-pet Tool behind the first two rows and hook the third row.

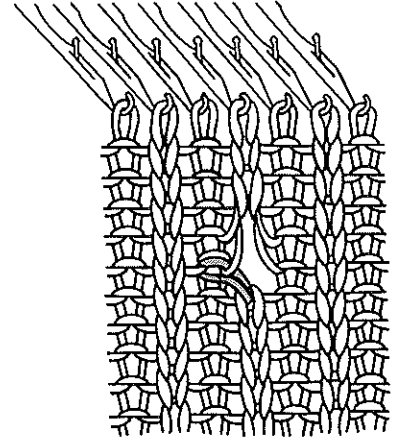

3. Continue to reform the stitches for K1.P1. Rib. Use the side as wrong side.

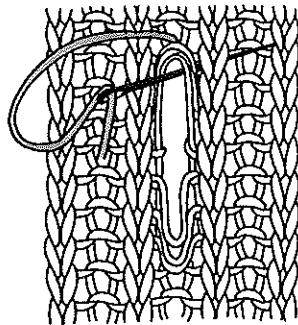
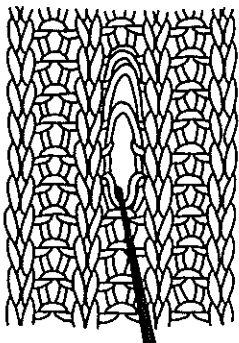

## Buttonhole by hand work

1. With the right side of the knitting facing you, pick up the loop of a purl stitch using a Crochet Hook at the point for the buttonhole, and pull the yarn. By inserting a pencil or your fingertip into the knitting, make the hole big enough to take a button.

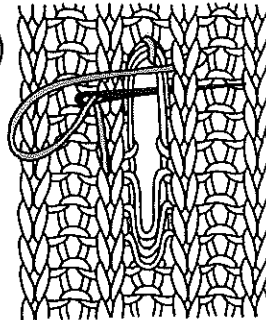
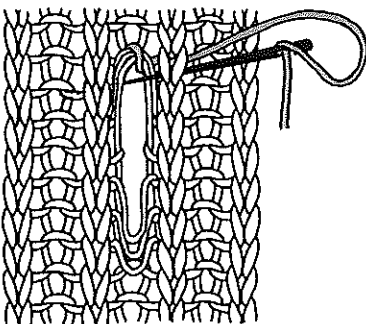

2. Thread the main yarn into a Tapestry Needle, and wrap the yarn around the top edge of the buttonhole, then guide the yarn under the pulled yarns, into the knit stitch from the rear side.

3. Insert the yarn into the same stitch, and pull it out over the pulled yarns.

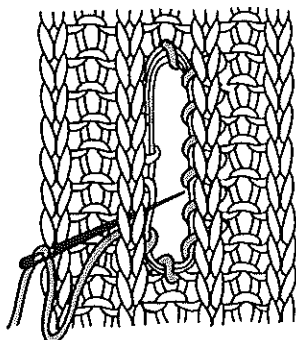

4. Guide the yarn around the knit stitch on the next row from the rear side so as to hold the pulled yarn.

5. Repeat steps 3 ~ 4 along the buttonhole.

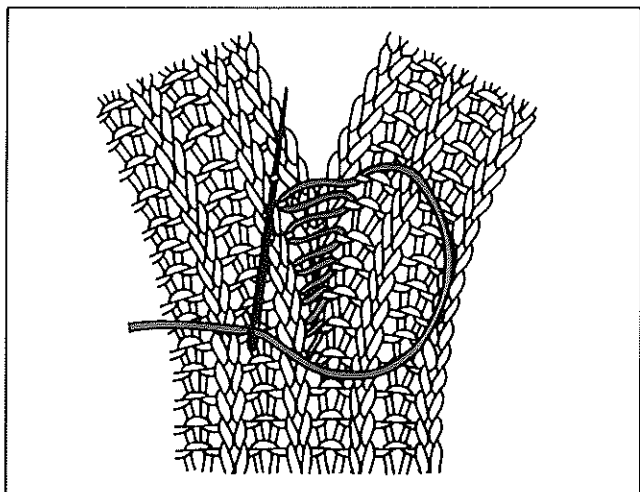

### K1. P1. Rib.—

With the side to be used as the right side facing you, pick up the sinker loops between the first 2 edge stitches.  
Repeat on every row.

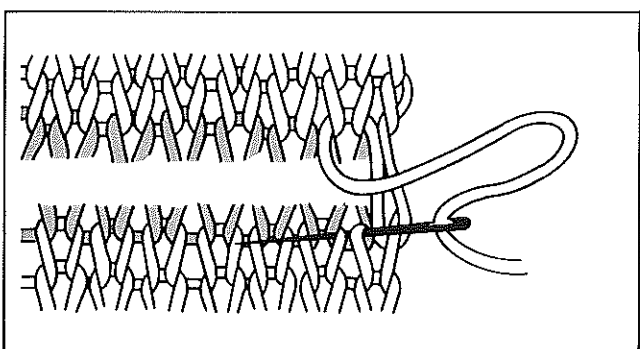

### Grafting

This is used to join two open rows, where the seam should be soft to the touch.

Align both pieces as shown and thread the knitting yarn through the stitches with the Tapestry Needle.

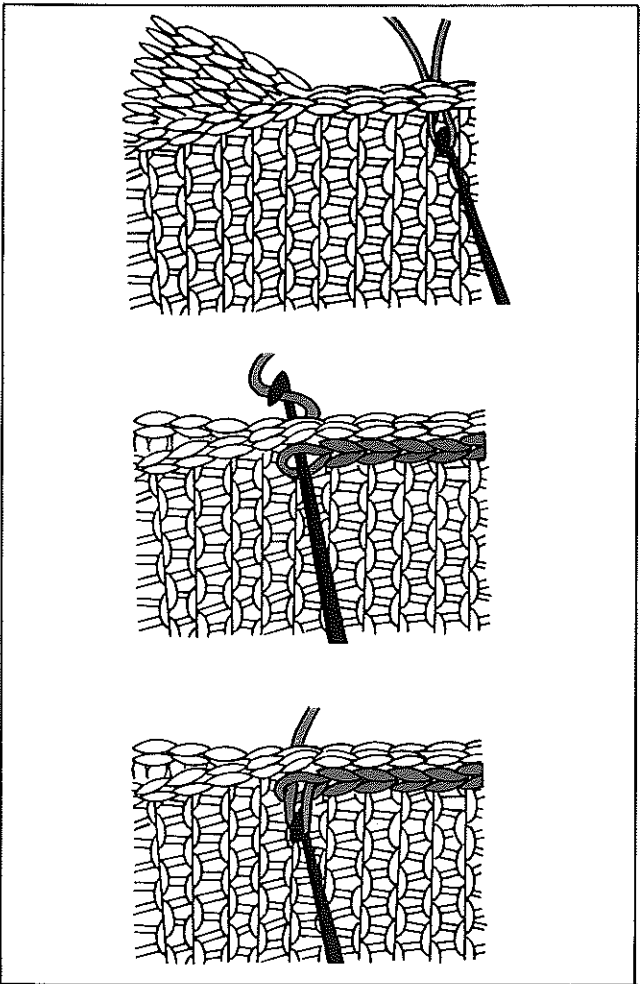

### Slip stitch

This is used for setting in sleeves or joining side seams.

1. Place the pieces to be joined with the right sides together. Insert the Crochet Hook into each sinker loop between the first 2 stitches from the edge. Catch the yarn and pull it through.
2. Insert the Crochet Hook into the next sinker loop and catch the yarn.

3. Pull back the Crochet hook.

Repeat steps 2 ~ 3.

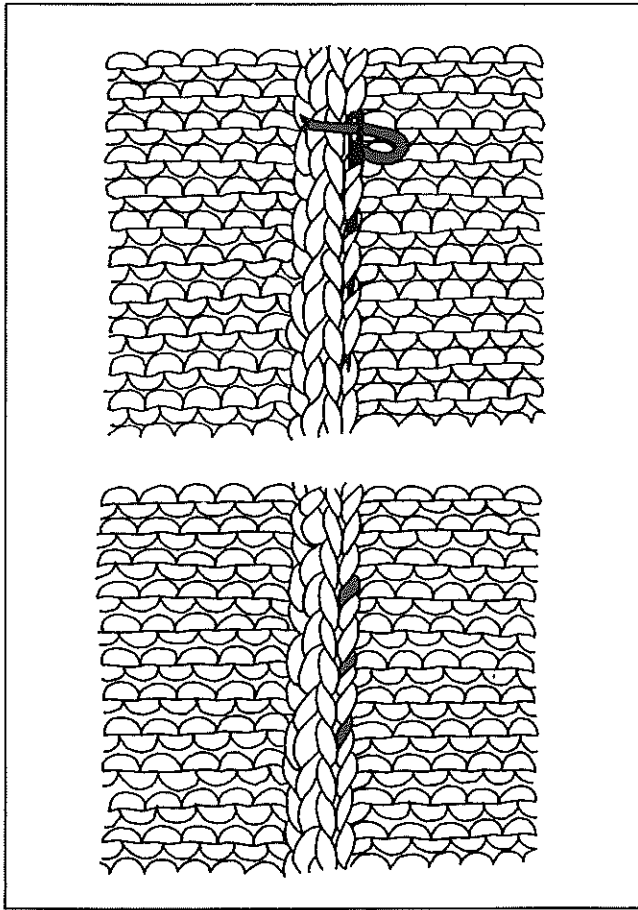

## Sew in yarn ends

Oversew the yarn ends into the seam.

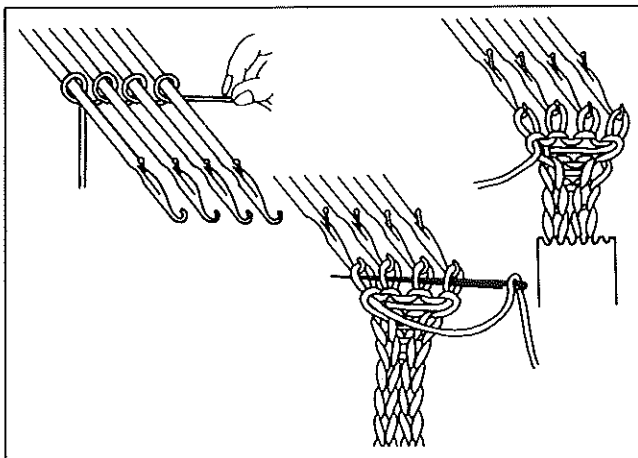
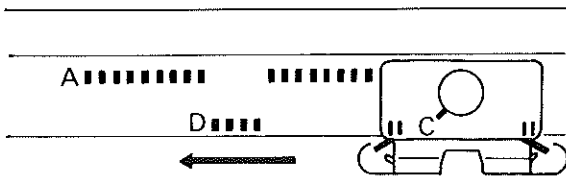

## Cord knitting

1. Place the Carriage at the right side of the Needle Bed and set the machine as follows.  
Cam Lever..... C  
Russel Levers..... II
2. Depending on the thickness of the cord, bring 3 ~ 5 needles to D position. Cast-on using the winding method as illustrated.
3. Move the Carriage back and forth five times, then hang Claw Weight.
4. Continue until the desired length has been knitted.

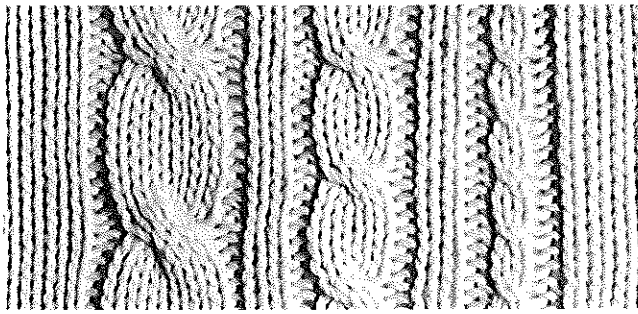

## Cable pattern

Cable patterns are formed by crossing a group of stitches over another group of stitches using two Transfer Tools.

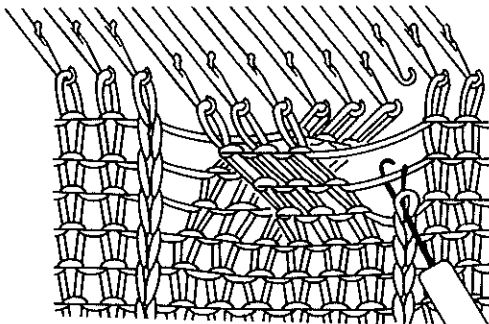
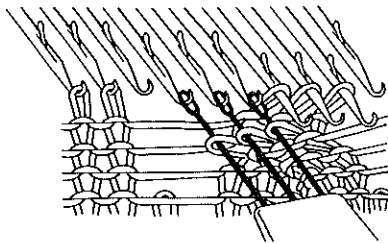
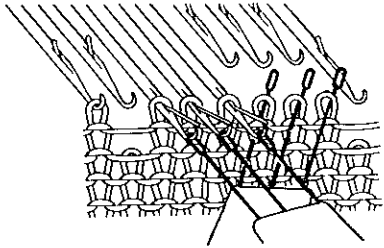

Try a six stitch cable.

1. Drop two outside stitches of the 6 stitches to be cabled. Using 2 3-prong Transfer Tools, remove the 6 stitches from their needles. Hold those stitches on the Transfer Tools with their prongs kept upwards.
2. Cross those 2 Transfer Tools. Place the left-hand 3 stitches onto the right-hand needles. Place the remaining stitches onto the left-hand needles.
3. Unravel the dropped stitches right down to the first row. Reform the stitches and replace on their needles.
4. Before knitting, push those 6 needles into C position, and continue to knit to the next position for crossing the stitches and repeat the above procedure.

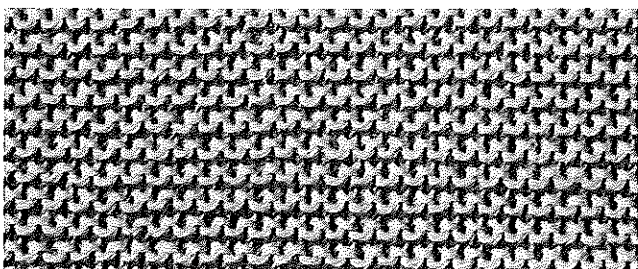

## Garter stitch

Garter stitch is used for laps, collars, borders, etc.

Knit Stockinet purling the stitches every other row.

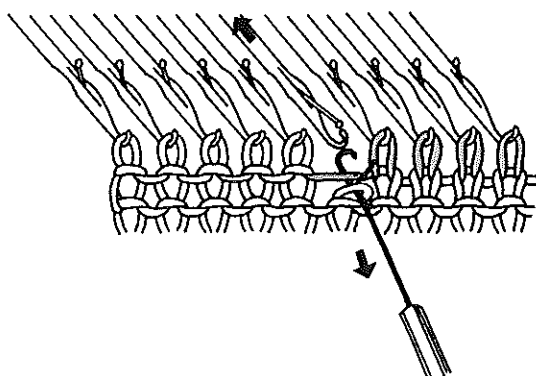

1. Set the Stitch Dial 2 numbers lower than for Stockinet knitting. Knit 2 rows in Stockinet.
2. Insert the Tappet Tool into the stitch below the stitch on the needle, and push the needle to D position.
3. Push the needle back to B position, allowing the stitch to come undone. Catch the loop in the hook of the Tappet Tool, and pull the loop through the stitch already on the Tappet Tool.



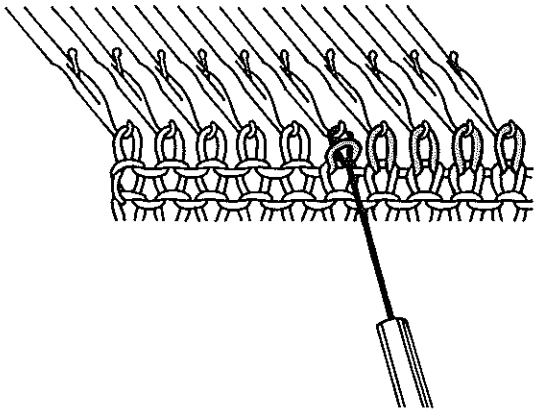

4. Place the newly formed stitch back onto the needle.

Repeat steps 2 ~ 4 for all stitches on the row.

5. Knit 2 rows in Stockinet and re-form the stitches on the second row in the same manner as done in steps 2 ~ 4.

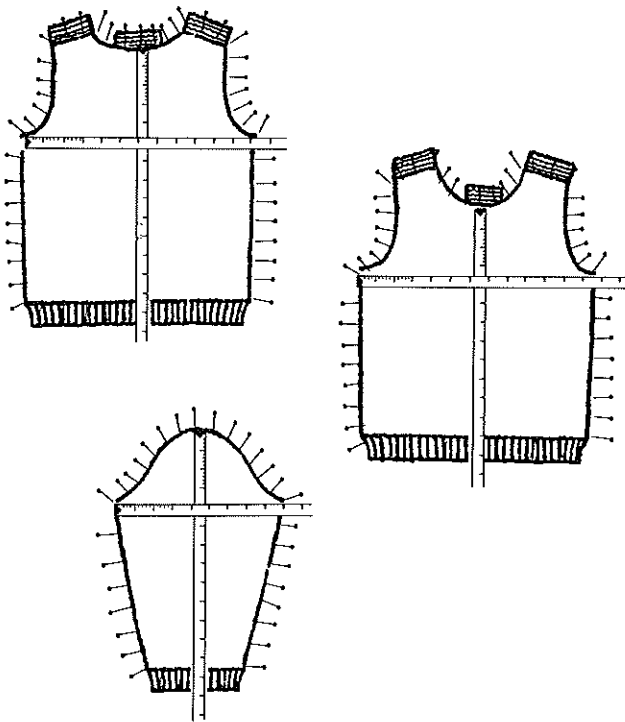

### Blocking and pressing

After knitting the pieces of your garment, you must lay them flat and pin them out to their correct shape and size.

1. Pin out a piece with its wrong side facing up on an ironing board. Pin the widest part of the piece first, then measure and pin to the correct length.
2. Pin all around the edges, spacing the pins about 2 ~ 3cm. apart. (Place the pins inside the ribbed edge.)
3. Press them lightly with a steam iron or over a damp cloth.
4. Leave the pieces to dry before removing the pins.

# IF MISTAKE OCCUR DURING KNITTING

## *Stockinet knitting*

Unravel the incorrectly knitted rows and align the needles in B position. Using Release Lever, move the Carriage to the yarn side.  
(See page 103 of Operation Manual.)

Turn back the Row Counter by the same number of rows as you have unravelled.

Continue knitting.

## *Vertical expansion (Pattern Switch 3 is used)*

Unravel an even number of knitted rows and align the needles in B position.  
(See page 103 of Operation Manual.)

Turn back the Row Counter by the same number of rows as you have unravelled.

Press "ON" the Inspection Switch. Return the Pattern Card by half the number of rows unravelled.

Press "OFF" the Inspection Switch and start knitting.

## *Pattern knitting*

Unravel the incorrectly knitted rows and align the needles in B position.  
In lace knitting, if there are empty needles on the row to be unravelled, replace the stitches on their original needles before unravelling.

Turn back the Row Counter by the same number of rows as you have unravelled.

Press "ON" the Inspection Switch.

Turn back the Pattern Card by the same number of rows as you have unravelled.  
In Fashion Lace knitting, the row with the black Notation Column should NOT be counted as unravelling row.

Using Release Lever, move the Carriage to the yarn side. (If the Lace Carriage is in use, set the Cam Lever to "N" and move it to the yarn side.)

Press "OFF" the Inspection Switch and start knitting.

# OPTIONAL ATTACHMENTS

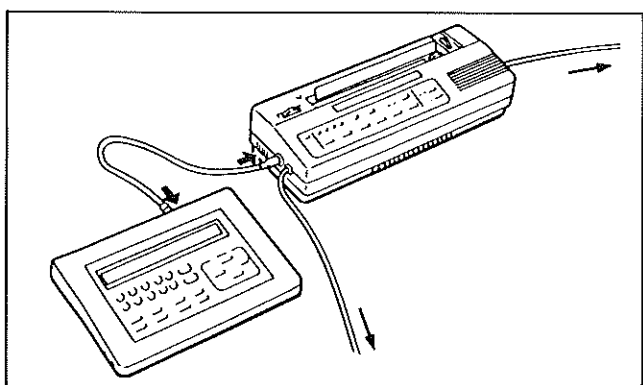

## Design Controller, PE 1

By using the Design Controller, you can knit a much larger pattern than the 150 rows by 60 sts. that fit on a single Pattern Card, and Multi-Coloured Jacquard. You can also store patterns onto a Memory Card.

Plug the connection cord into the socket at the top of the Design Controller and on the left side of the Pattern Controller.

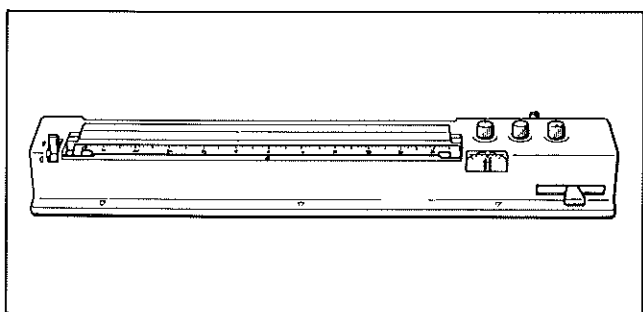

## Knit Contour

This Knit Contour tells you how many stitches to increase or decrease, where to increase or decrease and how many rows to knit for shaping garments.

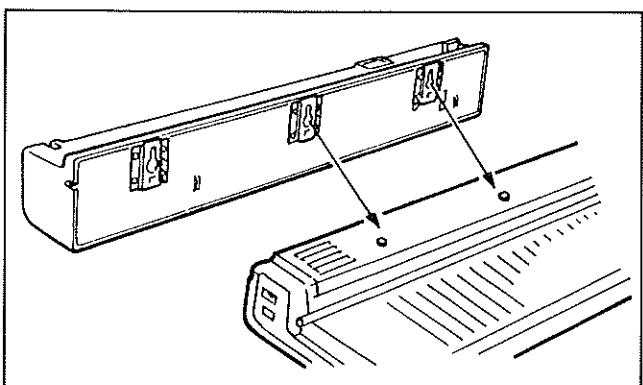

## Mechanical-feed Knit Contour

Fit the right 2 slots of the Knit Contour into the studs on the top of the machine and slide it backwards until click.

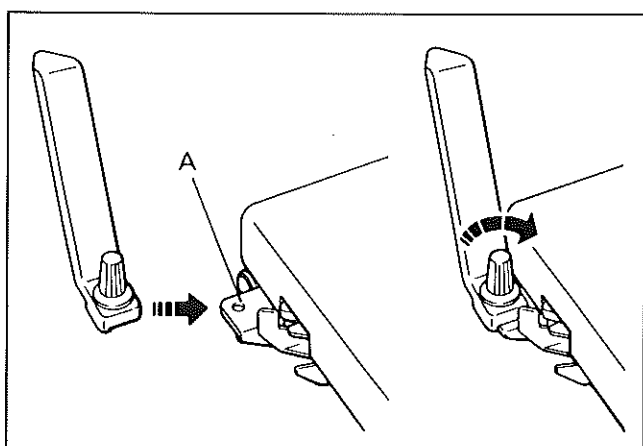

Attach the Knit Contour Feeding Cam to the left extension plate "A".

N.B. If the tension gauge is less than lowest limit 30 rows, select a number twice the row number read on the Gauge Scale.

### Electronic Knit Contour

Plug the connecting cord into the sockets at the top of the Row Counter and on the right side of the Knit Contour.

Use the lid of the Accessory Box as a tray for the Knit Contour by fitting it into the studs on the top of the machine. Put the Knit Contour 2cm. apart from this side's edge of the tray.

